

# Dell™ Latitude™ D610 User's Guide

[Finding Information](#)

[About Your Computer](#)

[Using Microsoft® Windows® XP](#)

[Dell™ QuickSet](#)

[Using the Keyboard and Touch Pad](#)

[Using the Display](#)

[Using CDs, DVDs, and Other Multimedia](#)

[Using a Battery](#)

[Wireless Local Area Network](#)

[Using PC Cards](#)

[Using Smart Cards](#)

[Travelling With Your Computer](#)

[Passwords](#)

[Using the Module Bay](#)

[Solving Problems](#)

[Using the Dell Diagnostics](#)

[Cleaning Your Computer](#)

[Reinstalling Software](#)

[Adding and Replacing Parts](#)

[Using the System Setup Program](#)

[Alert Standard Format \(ASF\)](#)

[Getting Help](#)

[Specifications](#)



[Appendix](#)

[Glossary](#)

---

Click the links to the left for information on the features and operation of your computer. For information on other documentation included with your computer, see "[Finding Information](#)."

## Notes, Notices, and Cautions

-  **NOTE:** A NOTE indicates important information that helps you make better use of your computer.
-  **NOTICE:** A NOTICE indicates either potential damage to hardware or loss of data and tells you how to avoid the problem.
-  **CAUTION:** A CAUTION indicates a potential for property damage, personal injury, or death.

## Abbreviations and Acronyms

For a complete list of abbreviations and acronyms, see the [Glossary](#).

If you purchased a Dell™ n Series computer, any references in this document to Microsoft® Windows® operating systems are not applicable.

-  **NOTE:** Some features may not be available for your computer or in certain countries.

---

Information in this document is subject to change without notice.  
© 2004–2005 Dell Inc. All rights reserved.

Reproduction in any manner whatsoever without the written permission of Dell Inc. is strictly forbidden.

Trademarks used in this text: *Dell*, the *DELL* logo, *Inspiron*, *XPS*, *Dell Precision*, *Dimension*, *OptiPlex*, *Latitude*, *Dell TravelLite*, *PowerEdge*, *PowerVault*, *PowerApp*, *ExpressCharge*, *Strike Zone*, and *Dell OpenManage* are trademarks of Dell Inc.; *Intel*, *Intel SpeedStep*, and *Pentium* are registered trademarks of Intel Corporation; *Microsoft*, *MS-DOS*, *Outlook*, and *Windows* are registered trademarks of Microsoft Corporation; *Bluetooth* is a registered trademark owned by Bluetooth SIG, Inc. and is used by Dell Inc. under license; *EMC* is a registered trademark of EMC Corporation; *ENERGY STAR* is a registered trademark of the U.S. Environmental Protection Agency. As an ENERGY STAR partner, Dell Inc. has determined that this product meets the ENERGY STAR guidelines for energy efficiency.

Other trademarks and trade names may be used in this document to refer to either the entities claiming the marks and names or their products. Dell Inc. disclaims any proprietary interest in trademarks and trade names other than its own.

Model PP11L

December 2005 P/N P4946 Rev. A03

## About Your Computer

### Dell™ Latitude™ D610 User's Guide

- [Front View](#)
  - [Left View](#)
  - [Right View](#)
  - [Back View](#)
  - [Bottom View](#)
- 

### Front View

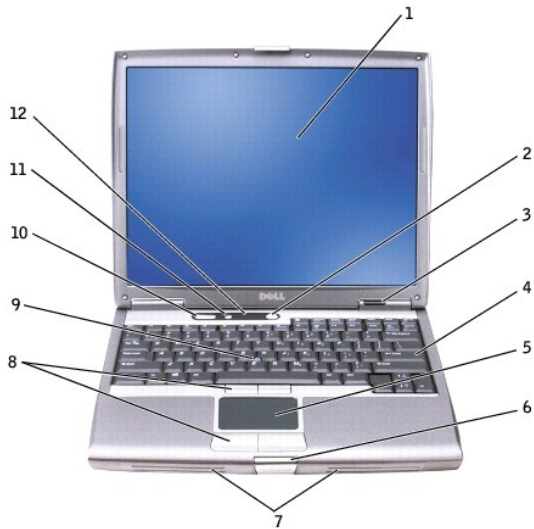

1	<a href="#">display</a>	7	<a href="#">speakers</a>
2	<a href="#">power button</a>	8	<a href="#">track stick/touch pad buttons</a>
3	<a href="#">device status lights</a>	9	<a href="#">track stick</a>
4	<a href="#">keyboard</a>	10	<a href="#">volume control buttons</a>
5	<a href="#">touch pad</a>	11	<a href="#">mute button</a>
6	<a href="#">display latch</a>	12	<a href="#">keyboard and wireless status lights</a>

**display** — For more information about your display, see "[Using the Display](#)."

**power button** — Press the power button to turn on the computer or exit a power management mode.







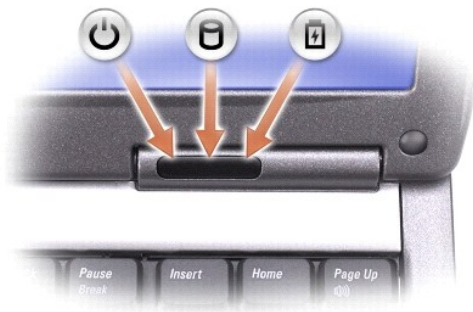

**NOTICE:** To avoid losing data, turn off your computer by performing a Microsoft® Windows® operating system shutdown rather than by pressing the power button.

If the computer stops responding, press and hold the power button until the computer turns off completely (which may take several seconds).

**device status lights**



	Turns on when you turn on the computer and blinks when the computer is in a power management mode.
	Turns on when the computer reads or writes data.
	<b>NOTICE:</b> To avoid loss of data, never turn off the computer while the  light is flashing.
	Turns on steadily or blinks to indicate battery charge status.

If the computer is connected to an electrical outlet, the  light operates as follows:

- o Solid green: The battery is charging.
- o Flashing green: The battery is almost fully charged.

If the computer is running on a battery, the  light operates as follows:

- o Off: The battery is adequately charged (or the computer is turned off).
- o Flashing orange: The battery charge is low.
- o Solid orange: The battery charge is critically low.

**keyboard** — The keyboard includes a numeric keypad as well as the Windows logo key. For information on supported keyboard shortcuts, see "[Using the Keyboard and Touch Pad](#)."

**touch pad** — Provides the functionality of a mouse. See "[Using the Keyboard and Touch Pad](#)" for more information.

**display latch** — Keeps the display closed.

**speakers** — To adjust the volume of the integrated speakers, press the volume control buttons, mute button, or volume-control keyboard shortcuts. For more information, see "[Using the Keyboard and Touch Pad](#)."

**track stick/touch pad buttons** — Provide the functionality of a mouse. See "[Using the Keyboard and Touch Pad](#)" for more information.

**track stick** — Provides the functionality of a mouse. See "[Using the Keyboard and Touch Pad](#)" for more information.

**volume control buttons** — Press these buttons to adjust the volume.

**mute button** — Press this button to turn off the volume.

**keyboard and wireless status lights**



The green lights located above the keyboard indicate the following:

	Turns on when the numeric keypad is enabled.
	Turns on when wireless devices are enabled.
	Turns on when the uppercase letter function is enabled.
	Turns on when Mini PCI functionality and Bluetooth® wireless technology are enabled. To enable or disable Mini PCI functionality and Bluetooth wireless technology, press <Fn><F2>.  <b>NOTE:</b> Bluetooth wireless technology is an optional feature on your computer, so the  icon turns on only if you ordered Bluetooth wireless technology with your computer.  For more information, see the documentation that came with your Bluetooth wireless technology.
	Turns on when the scroll lock function is enabled.

## Left View



1	<a href="#">security cable slot</a>	4	<a href="#">PC Card slot</a>
2	<a href="#">audio connectors</a> (2)	5	<a href="#">smart card slot</a>
3	<a href="#">infrared sensor</a>	6	<a href="#">hard drive</a>

**PC Card slot** — Supports one PC Card, such as a modem or network adapter. The computer ships with a plastic blank installed in the slot. For more information, see "[Using PC Cards](#)."



**smart card slot** — Supports one smart card. For more information, see "[Using Smart Cards](#)."

**infrared sensor** — Lets you transfer files from your computer to another infrared-compatible device without using cable connections.

When you receive your computer, the sensor is disabled. You can use the system setup program to enable the sensor. For information on transferring data, see *Windows Help*, the *Help and Support Center*, or the documentation that came with your infrared-compatible device.

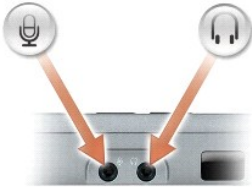
#### audio connectors



Attach headphones or speakers to the  connector.
Attach a microphone to the  connector.

**hard drive** — Stores software and data.

**security cable slot** — Lets you attach a commercially available antitheft device to the computer. For more information, see the instructions included with the device.

 **NOTICE:** Before you buy an antitheft device, ensure that it will work with the security cable slot.



#### Right View



1	<a href="#">module bay</a>
2	<a href="#">device latch release</a>

3 [USB connectors \(2\)](#)

**module bay** — You can install devices such as an optical drive or a Dell Travellite™ module in the module bay. For more information, see "[Using the Module Bay](#)."

**device latch release** — Releases the module bay device. See "[Using the Module Bay](#)" for instructions.

### Back View

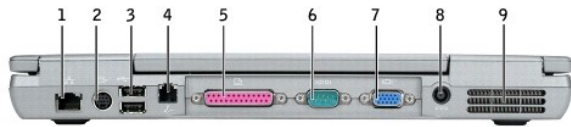

1	<a href="#">network connector (RJ-45)</a>	6	<a href="#">serial connector</a>
2	<a href="#">S-video TV-out connector</a>	7	<a href="#">video connector</a>
3	<a href="#">USB connectors (2)</a>	8	<a href="#">AC adapter connector</a>
4	<a href="#">modem connector (RJ-11)</a>	9	<a href="#">air vents</a>
5	<a href="#">parallel connector</a>		

#### USB connectors

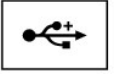
	Connect USB devices, such as a mouse, keyboard, or printer. You can also connect the optional floppy drive directly to a USB connector using the optional floppy drive cable.
--	---

#### S-video TV-out connector

	Connects your computer to a TV. For more information, see " <a href="#">Connecting Your Computer to a TV or Audio Device</a> ."
---	---

#### modem connector (RJ-11)

	If you ordered the optional internal modem, connect the telephone line to the modem connector. For information on using the modem, see the online modem documentation supplied with your computer.
---	---

#### network connector (RJ-45)

**NOTICE:** The network connector is slightly larger than the modem connector. To avoid damaging the computer, do not plug a telephone line into the network connector.

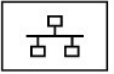
	Connects the computer to a network. The two lights next to the connector indicate the status of both the connection and the transfer of information for wired network communications. For information on using the network adapter, see the device user's guide supplied with your computer. See " <a href="#">Finding Information</a> ."
---	--

#### parallel connector

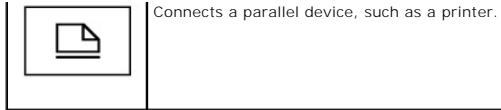

#### video connector

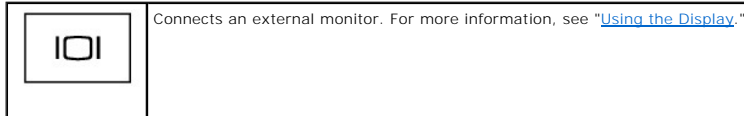

#### serial connector

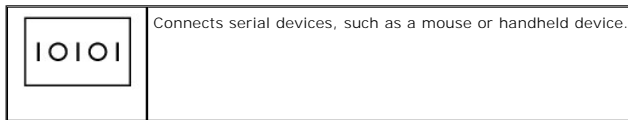

**AC adapter connector** — Attach an AC adapter to the computer.



The AC adapter converts AC power to the DC power required by the computer. You can connect the AC adapter with your computer turned either on or off.

**CAUTION:** The AC adapter works with electrical outlets worldwide. However, power connectors and power strips vary among countries. Using an incompatible cable or improperly connecting the cable to the power strip or electrical outlet may cause fire or equipment damage.

**NOTICE:** When you disconnect the AC adapter cable from the computer, grasp the connector, not the cable itself, and pull firmly but gently to avoid damaging the cable.

**air vents** — The computer uses an internal fan to create airflow through the vents, which prevents the computer from overheating.

**CAUTION:** Do not block, push objects into, or allow dust to accumulate in the air vents. Do not store your computer in a low-airflow environment, such as a closed briefcase, while it is running. Restricting the airflow can damage the computer or cause a fire.

**NOTE:** The computer turns on the fan when the computer gets hot. Fan noise is normal and does not indicate a problem with the fan or the computer.

---

## Bottom View

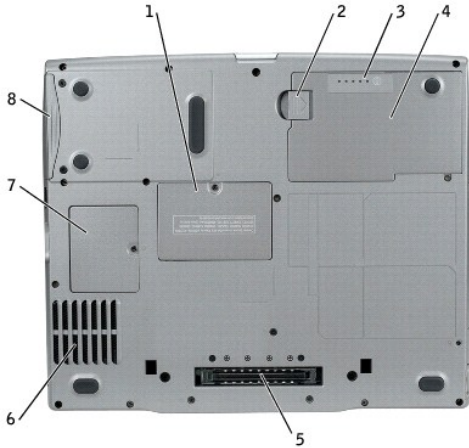

1	<a href="#">memory module cover</a>	5	<a href="#">docking device slot</a>
2	<a href="#">battery-bay latch release</a>	6	<a href="#">fan</a>
3	<a href="#">battery charge gauge</a>	7	<a href="#">modem/coin-cell battery cover</a>
4	<a href="#">battery</a>	8	<a href="#">hard drive</a>

**memory module cover** — Covers the compartment that contains the memory module(s). See "[Adding and Replacing Parts.](#)"

**battery-bay latch release** — Releases the battery. See [Using a Battery](#) for instructions.

**battery charge gauge** — Provides information on the battery charge. See [Using a Battery](#).

**battery** — When a battery is installed, you can use the computer without connecting the computer to an electrical outlet. See [Using a Battery](#).

**docking device slot** — Lets you attach your computer to a docking device. See the documentation that came with your docking device for additional information.

**fan** — The computer uses an internal fan to create airflow through the vents, which prevents the computer from overheating.

**⚠ CAUTION:** Do not block, push objects into, or allow dust to accumulate in the air vents. Do not store your computer in a low-airflow environment, such as a closed briefcase, while it is running. Restricting the airflow can damage the computer or cause a fire.

**🔊 NOTE:** The computer turns on the fan when the computer gets hot. Fan noise is normal and does not indicate a problem with the fans or the computer.

**modem/coin-cell battery cover** — Covers the compartment that contains the modem and the coin-cell battery. See "[Adding and Replacing Parts.](#)"

**hard drive** — Stores software and data.

---

[Back to Contents Page](#)



[Back to Contents Page](#)

## Appendix

### Dell™ Latitude™ D610 User's Guide

- [Macrovision Product Notice](#)
- [FCC Notices \(U.S. Only\)](#)

---

## Macrovision Product Notice

This product incorporates copyright protection technology that is protected by method claims of certain U.S. patents and other intellectual property rights owned by Macrovision Corporation and other rights owners. Use of this copyright protection technology must be authorized by Macrovision Corporation, and is intended for home and other limited viewing uses only unless otherwise authorized by Macrovision Corporation. Reverse engineering or disassembly is prohibited.

---

## FCC Notices (U.S. Only)

Most Dell computers are classified by the Federal Communications Commission (FCC) as Class B digital devices. To determine which classification applies to your computer, examine all FCC registration labels located on the bottom, side, or back panel of your computer, on card-mounting brackets, and on the cards themselves. If any one of the labels carries a Class A rating, your entire computer is considered to be a Class A digital device. If *all* labels carry an FCC Class B rating as distinguished by either an FCC ID number or the FCC logo, (  ), your computer is considered to be a Class B digital device.

Once you have determined your computer's FCC classification, read the appropriate FCC notice. Note that FCC regulations provide that changes or modifications not expressly approved by Dell could void your authority to operate this equipment.

This device complies with Part 15 of the FCC Rules. Operation is subject to the following two conditions:

- 1 This device may not cause harmful interference.
- 1 This device must accept any interference received, including interference that may cause undesired operation.

### Class A

This equipment has been tested and found to comply with the limits for a Class A digital device pursuant to Part 15 of the FCC Rules. These limits are designed to provide reasonable protection against harmful interference when the equipment is operated in a commercial environment. This equipment generates, uses, and can radiate radio frequency energy and, if not installed and used in accordance with the manufacturer's instruction manual, may cause harmful interference with radio communications. Operation of this equipment in a residential area is likely to cause harmful interference, in which case you will be required to correct the interference at your own expense.

### Class B

This equipment has been tested and found to comply with the limits for a Class B digital device pursuant to Part 15 of the FCC Rules. These limits are designed to provide reasonable protection against harmful interference when the equipment is operated in a residential installation. This equipment generates, uses, and can radiate radio frequency energy and, if not installed and used in accordance with the manufacturer's instruction manual, may cause interference with radio communications. However, there is no guarantee that interference will not occur in a particular installation. If this equipment does cause harmful interference to radio or television reception, which can be determined by turning the equipment off and on, you are encouraged to try to correct the interference by one or more of the following measures:

- 1 Reorient or relocate the receiving antenna.
- 1 Increase the separation between the equipment and the receiver.
- 1 Connect the equipment into an outlet on a circuit different from that to which the receiver is connected.
- 1 Consult the dealer or an experienced radio/television technician for help.

## FCC Identification Information

The following information is provided on the device or devices covered in this document in compliance with FCC regulations:

- 1 Model number: PP11L

Company name:

Dell Inc.  
One Dell Way  
Round Rock, Texas 78682 USA  
512-338-4400

---

[Back to Contents Page](#)



[Back to Contents Page](#)

## Alert Standard Format (ASF)

### Dell™ Latitude™ D610 User's Guide

Alert Standard Format (ASF) is a Distributed Management Task Force (DMTF) management standard that specifies "pre-operating system" or "operating system absent" alerting techniques. The standard is designed to generate an alert on potential security and fault conditions when the operating system is in a sleep state or the system is turned off. ASF is designed to supersede previous operating system-absent alerting technologies.

Your computer supports the following ASF alerts and remote capabilities:

Alert	Description
Chassis Intrusion - Physical Security Violation/Chassis Intrusion - Physical Security Violation Event Cleared	The docking device has been opened and the PCI slot has been compromised.
Failure to Boot to BIOS	The BIOS did not complete loading upon initiation.
System Password Violation	The system password is invalid (alert occurs after three failed attempts).
Entity Presence	Periodic heartbeats have been transmitted to verify system presence.

For more information about Dell's ASF implementation, see *ASF for Dell Portable Computers* and the *ASF Administrator's Guide for Dell Portable Computers*, which are available on the Dell Support website at [support.dell.com](http://support.dell.com).

---

[Back to Contents Page](#)

[Back to Contents Page](#)

## Using a Battery

### Dell™ Latitude™ D610 User's Guide

- [Battery Performance](#)
- [Checking the Battery Charge](#)
- [Conserving Battery Power](#)
- [Power Management Modes](#)
- [Configuring Power Management Settings](#)
- [Charging the Battery](#)
- [Replacing the Battery](#)
- [Storing a Battery](#)

---

## Battery Performance

 **NOTE:** For information about the Dell warranty for your computer, see the *Product Information Guide* or separate paper warranty document that shipped with your computer.

For optimal computer performance and to help preserve BIOS settings, operate your Dell™ portable computer with the main battery installed at all times. One battery is supplied as standard equipment in the battery bay.

 **NOTE:** Because the battery may not be fully charged, use the AC adapter to connect your new computer to an electrical outlet the first time you use the computer. For best results, operate the computer with the AC adapter until the battery is fully charged. To view battery charge status, access the **Control Panel**→**Power Options**, and then click the **Power Meter** tab.

 **NOTE:** Battery operating time (the time the battery can hold a charge) decreases over time. Depending on how often the battery is used and the conditions under which it is used, you may need to purchase a new battery during the life of your computer.

Battery operating time varies depending on operating conditions. You can install an optional second battery in the media bay to significantly increase operating time.

Operating time is significantly reduced when you perform operations including, but not limited to, the following:

- 1 Using optical drives
- 1 Using wireless communications devices, PC Cards, ExpressCards, media memory cards, or USB devices
- 1 Using high-brightness display settings, 3D screen savers, or other power-intensive programs such as 3D games
- 1 Running the computer in maximum performance mode (see [Configuring Power Management Settings](#)).

 **NOTE:** It is recommended that you connect your computer to an electrical outlet when writing to a CD or DVD.

You can check the battery charge before you insert the battery into the computer (see [Checking the Battery Charge](#)). You can also set power management options to alert you when the battery charge is low (see [Configuring Power Management Settings](#)).

 **CAUTION:** Using an incompatible battery may increase the risk of fire or explosion. Replace the battery only with a compatible battery purchased from Dell. The lithium ion battery is designed to work with your Dell computer. Do not use a battery from other computers with your computer.

 **CAUTION:** Do not dispose of batteries with household waste. When your battery no longer holds a charge, call your local waste disposal or environmental agency for advice on disposing of a lithium-ion battery. See "Battery Disposal" in the *Product Information Guide*.

 **CAUTION:** Misuse of the battery may increase the risk of fire or chemical burn. Do not puncture, incinerate, disassemble, or expose the battery to temperatures above 65°C (149°F). Keep the battery away from children. Handle damaged or leaking batteries with extreme care. Damaged batteries may leak and cause personal injury or equipment damage.

---

## Checking the Battery Charge

The Dell QuickSet Battery Meter, the Microsoft Windows **Power Meter** window and  icon, the battery charge gauge and health gauge, and the low-battery warning provide information on the battery charge.

### Dell™ QuickSet Battery Meter

If Dell QuickSet is installed, press <Fn><F3> to display the QuickSet Battery Meter. The Battery Meter displays status, battery health, charge level, and charge completion time for the battery in your computer.

For more information about QuickSet, right-click the  icon in the taskbar, and click **Help**.

### Microsoft® Windows® Power Meter

The Windows Power Meter indicates the remaining battery charge. To check the Power Meter, double-click the  icon on the taskbar.

If the computer is connected to an electrical outlet, a  icon appears.

## Charge Gauge

By either pressing once or *pressing and holding* the status button on the charge gauge on the battery, you can check:



- 1 Battery charge (check by pressing and *releasing* the status button)
- 1 Battery health (check by pressing and *holding* the status button)

The battery operating time is largely determined by the number of times it is charged. After hundreds of charge and discharge cycles, batteries lose some charge capacity—or battery health. That is, a battery can show a status of “charged” but maintain a reduced charge capacity (health).

## Check the Battery Charge

To check the battery charge, *press and release* the status button on the battery charge gauge to illuminate the charge-level lights. Each light represents approximately 20 percent of the total battery charge. For example, if the battery has 80 percent of its charge remaining, four of the lights are on. If no lights appear, the battery has no charge.

## Check the Battery Health

 **NOTE:** You can check battery health in one of two ways: by using the charge gauge on the battery as described below and by using the Battery Meter in Dell QuickSet. For information about QuickSet, right-click the  icon in the taskbar, and click **Help**.

To check the battery health using the charge gauge, *press and hold* the status button on the battery charge gauge for at least 3 seconds. If no lights appear, the battery is in good condition, and more than 80 percent of its original charge capacity remains. Each light represents incremental degradation. If five lights appear, less than 60 percent of the charge capacity remains, and you should consider replacing the battery. See [Specifications](#) for more information about the battery operating time.

## Low-Battery Warning

 **NOTICE:** To avoid losing or corrupting data, save your work immediately after a low-battery warning. Then connect the computer to an electrical outlet. If the battery runs completely out of power, hibernate mode begins automatically.

By default, a pop-up window warns you when the battery charge is approximately 90 percent depleted. You can change the settings for the battery alarms in QuickSet or the **Power Options Properties** window. See [Configuring Power Management Settings](#) for information about accessing QuickSet or the **Power Options Properties** window.

---

## Conserving Battery Power

Perform the following actions to conserve battery power:

- 1 Connect the computer to an electrical outlet when possible because battery life is largely determined by the number of times the battery is used and recharged.
- 1 Place the computer in standby mode or hibernate mode when you leave the computer unattended for long periods of time (see [Power Management Modes](#)).
- 1 Use the Power Management Wizard to select options to optimize your computer's power usage. These options can also be set to change when you press the power button, close the display, or press <Fn><Esc>.

 **NOTE:** See [Power Management Modes](#) for more information on conserving battery power.

---

## Power Management Modes

### Standby Mode

Standby mode conserves power by turning off the display and the hard drive after a predetermined period of inactivity (a time-out). When the computer exits standby mode, it returns to the same operating state it was in before entering standby mode.

 **NOTICE:** If your computer loses AC and battery power while in standby mode, it may lose data.

To enter standby mode:

- 1 Click **Start**→**Shut Down**→**Stand by**.

or

- 1 Depending on how you set the power management options in the **Power Options Properties** window or the QuickSet Power Management Wizard, use one of the following methods:
  - o Press the power button.
  - o Close the display.
  - o Press <Fn><Esc>.

To exit standby mode, press the power button or open the display depending on how you set the power management options. You cannot make the computer exit standby mode by pressing a key or touching the touch pad or track stick.

## Hibernate Mode

Hibernate mode conserves power by copying system data to a reserved area on the hard drive and then completely turning off the computer. When the computer exits hibernate mode, it returns to the same operating state it was in before entering hibernate mode.

 **NOTICE:** You cannot remove devices or undock your computer while your computer is in hibernate mode.

Your computer enters hibernate mode if the battery charge level becomes critically low.

To manually enter hibernate mode:

- 1 Click **Start**→ **Turn off computer**, press and hold <Shift>, and then click **Hibernate**.
- or
- 1 Depending on how you set the power management options in the **Power Options Properties** window or the QuickSet Power Management Wizard, use one of the following methods to enter hibernate mode:
    - o Press the power button.
    - o Close the display.
    - o Press <Fn><Esc>.

 **NOTE:** Some PC Cards or ExpressCards may not operate correctly after the computer exits hibernate mode. Remove and reinsert the card (see [Installing a PC Card](#)), or simply restart (reboot) your computer.

To exit hibernate mode, press the power button. The computer may take a short time to exit hibernate mode. You cannot make the computer exit hibernate mode by pressing a key or touching the touch pad or track stick. For more information on hibernate mode, see the documentation that came with your operating system.

---

## Configuring Power Management Settings

You can use the QuickSet Power Management Wizard or Windows Power Options Properties to configure the power management settings on your computer.

- 1 To access the QuickSet Power Management Wizard, double-click the  icon in the taskbar. For more information about QuickSet, click the **Help** button in the Power Management Wizard.
- 1 To access the **Power Options Properties** window, click the **Start** button→ **Control Panel**→ **Performance and Maintenance**→ **Power Options**. For information on any field in the Power Options Properties window, click the question mark icon on the title bar and then click on the area where you need information.

---

## Charging the Battery

 **NOTE:** With Dell™ ExpressCharge™, when the computer is turned off, the AC adapter charges a completely discharged battery to 80 percent in about 1 hour and to 100 percent in approximately 2 hours. Charge time is longer with the computer turned on. You can leave the battery in the computer for as long as you like. The battery's internal circuitry prevents the battery from overcharging.

When you connect the computer to an electrical outlet or install a battery while the computer is connected to an electrical outlet, the computer checks the battery charge and temperature. If necessary, the AC adapter then charges the battery and maintains the battery charge.

If the battery is hot from being used in your computer or being in a hot environment, the battery may not charge when you connect the computer to an electrical outlet.

The battery is too hot to start charging if the  light flashes alternately green and orange. Disconnect the computer from the electrical outlet and allow the computer and the battery to cool to room temperature. Then connect the computer to an electrical outlet to continue charging the battery.

For more information about resolving problems with a battery, see [Power Problems](#).

---

## Replacing the Battery

**⚠ CAUTION:** Before performing these procedures, turn off the computer, disconnect the AC adapter from the electrical outlet and the computer, disconnect the modem from the wall connector and computer, and remove any other external cables from the computer.

**🔄 NOTICE:** You must remove all external cables from the computer to avoid possible connector damage.

**⚠ CAUTION:** Using an incompatible battery may increase the risk of fire or explosion. Replace the battery only with a compatible battery purchased from Dell. The battery is designed to work with your Dell™ computer. Do not use a battery from other computers with your computer.

To remove the battery:

1. If the computer is connected to a docking device (docked), undock it. See the documentation that came with your docking device for instructions.
2. Ensure that the computer is turned off or suspended in a power management mode.
3. Slide and hold the battery-bay (or module-bay) latch release, and then remove the battery from the bay.

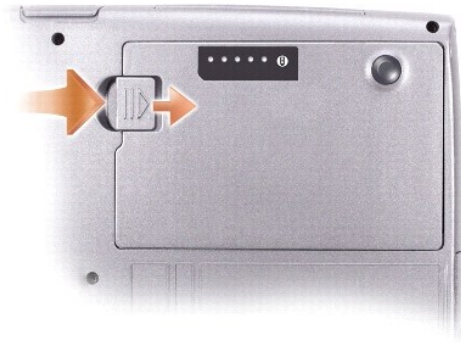

To replace the battery, follow the removal procedure in reverse order.

---

## Storing a Battery

Remove the battery when you store your computer for an extended period of time. A battery discharges during prolonged storage. After a long storage period, recharge the battery fully before you use it (see [Charging the Battery](#)).

---

[Back to Contents Page](#)

[Back to Contents Page](#)

## Using the Module Bay

Dell™ Latitude™ D610 User's Guide

- [About the Module Bay](#)
  - [About the Device Security Screw](#)
  - [Removing and Installing Devices While the Computer Is Turned Off](#)
  - [Removing and Installing Devices While the Computer Is Running](#)
- 

### About the Module Bay

**⚠ CAUTION:** Before you begin any of the procedures in this section, follow the safety instructions in the *Product Information Guide*.

You can install devices such as a floppy drive, CD drive, CD-RW drive, DVD drive, CD-RW/DVD drive, DVD+RW, second battery, or second hard drive in the module bay.

---

### About the Device Security Screw

**🔧 NOTE:** You do not need to install the device security screw unless you want to prevent the module from being easily removed.

Your Dell™ computer ships with a CD/DVD drive installed in the module bay and a device security screw, which is not installed in the CD/DVD drive but packaged separately. When you install a module in the bay, you can install the device security screw to prevent the module from being easily removed.

### Removing the Device Security Screw

If the device security screw is installed, you must remove the screw to remove the module from the bay:

1. Save and close any open files, exit any open programs, and shut down the computer.
2. If the computer is connected to a docking device (docked), undock it. See the documentation that came with your docking device for instructions.
3. Close the display and turn the computer over.
4. Use a #1 Phillips screwdriver to remove the device security screw from the bottom of the computer.



---

### Removing and Installing Devices While the Computer Is Turned Off

**🔧 NOTE:** If the device security screw is not installed, you can remove and install devices while the computer is running and connected to a docking device (docked).

**👉 NOTICE:** To prevent damage to devices, store them in a safe, dry place when they are not installed in the computer. Avoid pressing down on them or placing heavy objects on top of them.

1. If the [device security screw](#) is installed, remove it.
2. Press the device latch release.





3. Pull the device out of the module bay.



4. Push the new device into the bay until it clicks.

---

## Removing and Installing Devices While the Computer Is Running

⚠ **NOTICE:** If the device security screw is installed, you must turn off the computer before removing the screw.

1. Before ejecting the device, double-click the **Safely Remove Hardware** icon on the taskbar, click the device you want to eject, and click **Stop**.

⚠ **NOTICE:** To prevent damage to devices, store them in a safe, dry place when they are not installed in the computer. Avoid pressing down on them or placing heavy objects on top of them.

2. Press the device latch release.



3. Pull the device out of the module bay.



4. Push the new device into the bay until it clicks.  
The operating system automatically recognizes the device.
5. If necessary, enter your password to unlock your computer.

---

[Back to Contents Page](#)

## Using CDs, DVDs, and Other Multimedia

### Dell™ Latitude™ D610 User's Guide

- [Playing a CD or DVD](#)
  - [Adjusting the Volume](#)
  - [Adjusting the Picture](#)
  - [Connecting Your Computer to a TV or Audio Device](#)
- 

### Playing a CD or DVD

- ➔ **NOTICE:** Do not press down on the CD or DVD tray when you open or close it. Keep the tray closed when you are not using the drive.
- ➔ **NOTICE:** Do not move the computer when you are playing CDs or DVDs.

1. Press the eject button on the front of the drive.
2. Pull the tray out.



3. Place the disc, label side up, in the center of the tray and snap the disc onto the spindle.

 **NOTE:** If you use a module that shipped with another computer, you need to install the drivers and software necessary to play DVDs or write data. For more information, see the optional *Drivers and Utilities* CD.

4. Push the tray back into the drive.

To format CDs for storing data, to create music CDs, or to copy CDs, see the CD software that came with your computer.

 **NOTE:** Ensure that you follow all copyright laws when you create CDs.

---

### Adjusting the Volume

 **NOTE:** When the speakers are muted, you do not hear the CD or DVD playing.

1. Click the **Start** button, point to **All Programs** (or **Programs**)→ **Accessories**→ **Entertainment** (or **Multimedia**), and then click **Volume Control**.
2. In the **Volume Control** window, click and drag the bar in the **Volume Control** column and slide it up or down to increase or decrease the volume.

For more information on volume control options, click **Help** in the **Volume Control** window.

The Volume Meter displays the current volume level, including mute, on your computer. Either right-click the  icon in the taskbar or press the [volume control buttons](#) to enable or disable the Volume Meter on the screen.

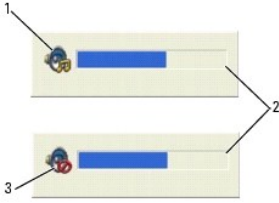

1	volume icon
2	Volume Meter
3	mute icon

When the meter is enabled, adjust the volume with the volume control buttons or by pressing the following keys:

- 1 Press <Fn> <PageUp> to increase volume.
- 1 Press <Fn> <PageDn> to decrease volume.
- 1 Press <Fn> <End> to mute volume.

For more information about QuickSet, right-click the  icon in the taskbar and click **Help**.

## Adjusting the Picture

If an error message notifies you that the current resolution and color depth are using too much memory and preventing DVD playback, adjust the display properties.

- 1. Click the **Start** button and click **Control Panel**.
- 2. Under **Pick a category**, click **Appearance and Themes**.
- 3. Under **Pick a task...**, click **Change the screen resolution**.
- 4. In the **Display Properties** window, click and drag the bar in **Screen resolution** to change the setting to **1024 by 768 pixels**.
- 5. Click the drop-down menu under **Color quality**, and then click **Medium (16 bit)**.
- 6. Click **OK**.

## Connecting Your Computer to a TV or Audio Device

 **NOTE:** Video and audio cables for connecting your computer to a TV or other audio device are not included with your computer and are not available in certain countries. If available in your country, cables may be purchased at most consumer electronics stores or from Dell.

Your computer has an S-video TV-out connector that, together with a standard S-video cable (available from Dell), enables you to connect the computer to a TV.

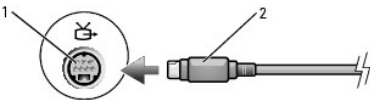

1	S-video TV-out connector
2	standard S-video cable connector

Your TV has either an S-video input connector or a composite video-input connector. Depending on what type of connector is available on your TV, you can use a commercially available S-video cable or composite video cable to connect your computer to your TV.

It is recommended that you connect video and audio cables to your computer in one of the following combinations.

 **NOTE:** See the diagrams at the beginning of each subsection to help you determine which method of connection you should use.

- 1 [S-video and standard audio](#)
- 1 [Composite video and standard audio](#)

When you finish connecting the video and audio cables between your computer and your TV, you must enable your computer to work with the TV. See "[Enabling the Display Settings for a TV in Microsoft® Windows® XP](#)" to ensure that the computer recognizes and works properly with the TV.

## S-Video and Standard Audio

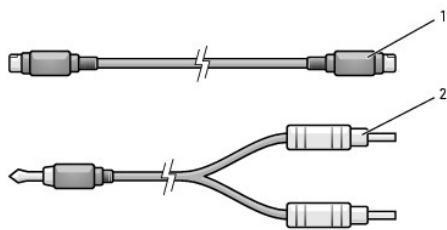
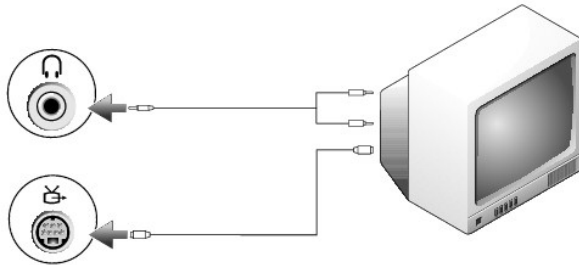

1	standard S-video cable
2	standard audio cable

1. Turn off the computer and the TV and/or audio device that you want to connect.

**NOTE:** You can connect an S-video cable directly to the S-video TV-out connector on the computer (without the TV/digital audio adapter cable) if your TV or audio device supports S-video but not S/PDIF digital audio.

2. Plug one end of the S-video cable in to the S-video input connector on the computer.

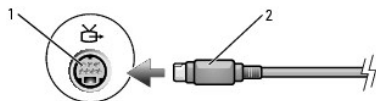

3. Plug the other end of the S-video cable in to the S-video input connector on your TV.
4. Plug the single-connector end of the audio cable in to the headphone connector on your computer.
5. Plug the two RCA connectors on the other end of the audio cable in to the audio input connectors on your TV or other audio device.
6. Turn on the TV and any audio device that you connected (if applicable), and then turn on the computer.
7. See "[Enabling the Display Settings for a TV in Microsoft® Windows® XP](#)" to ensure that the computer recognizes and works properly with the TV.

## Composite Video and Standard Audio

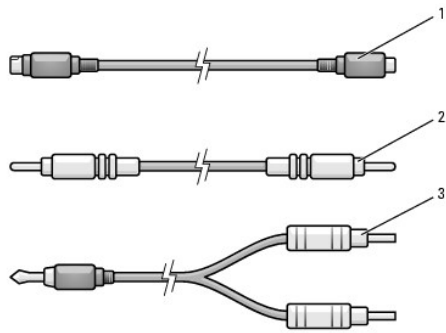
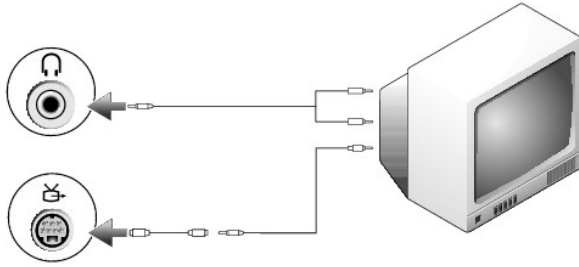

1	standard S-video to composite video adapter
2	composite video cable
3	standard audio cable

1. Turn off the computer and the TV and/or audio device that you want to connect.
2. Connect the standard video to composite video adapter cable to the S-video TV-out connector on the computer.
3. Plug one end of the composite video cable in to the composite video-input connector on the standard video to composite video cable.



4. Plug the other end of the composite video cable in to the composite video-input connector on the TV.
5. Plug the single-connector end of the audio cable in to the headphone connector on the computer.
6. Plug the two RCA connectors on the other end of the audio cable in to the audio input connectors on your TV or other audio device.
7. Turn on the TV, turn on any audio device that you connected (if applicable), and then turn on the computer.
8. See [Enabling the Display Settings for a TV in Microsoft® Windows® XP](#) to ensure that the computer recognizes and works properly with the TV.

## Enabling S/PDIF Digital Audio

If your computer has a DVD drive, you can enable digital audio for DVD playback.

1. Click **Start**→**Programs**→**PowerDVD** to launch the **Cyberlink PowerDVD** application.
2. Insert a DVD into the DVD drive.  
If the DVD begins playing, click the stop button.
3. Click the **Settings** option.



4. Click the **DVD** option.



5. Click the **DVD Audio Setting** icon.

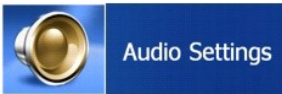

6. Click the arrows beside the **Speaker Configuration** setting to scroll through the options, and select the **SPDIF** option.



7. Click the **Back** button once, and then click the **Back** button again to return to the main menu screen.

### Enabling S/PDIF in the Windows Audio Driver

 **NOTE:** Enabling S/PDIF in Windows disables the sound from the headphone connector.

1. Double-click the speaker icon in the Windows notification area.
2. Click the **Options** menu and then click **Advanced Controls**.
3. Click **Advanced**.
4. Click **Enable S/PDIF**.
5. Click **Close**.
6. Click **OK**.

### Setting Up the Cyberlink (CL) Headphones

 **NOTE:** The CL headphone feature is available only if your computer has a DVD drive.

If your computer has a DVD drive, you can enable digital audio for DVD playback.

1. Click **Start→Programs→PowerDVD** to launch the **Cyberlink PowerDVD** program.
2. Insert a DVD into the DVD drive.  
If the DVD begins playing, click the stop button.
3. Click the **Settings** option.



4. Click the **DVD** option.



5. Click the **DVD Audio Setting** icon.



6. Click the arrows beside the **Speaker Configuration** setting to scroll through the options, and select the **Headphones** option.
7. Click the arrows beside the **Audio listening mode** setting to scroll through the options, and select the **CL Headphone** option.
8. Click the arrows beside the **Dynamic range compression** option to select the most suitable option.



9. Click the **Back** button once, and then click the **Back** button again to return to the main menu screen.

## Enabling the Display Settings for a TV in Microsoft® Windows® XP

Your computer has either an integrated video controller (Intel® Extreme Graphics) or a discrete video controller (ATI Mobility Radeon X300). To enable the display settings for a TV on your computer, follow the instructions that apply to your computer configuration.

**NOTE:** Ensure that you properly connect the TV before you enable the display settings.

### Integrated Video Controller

1. Click the **Start** button and click **Control Panel**.
2. Click **Appearances and Themes**.
3. Under **or pick a Control Panel icon**, click **Display**.
4. Click the **Settings** tab and click **Advanced**.
5. Click the **Intel (R) Extreme Graphics** tab.
6. Click **Graphic Properties**.
7. If you want to use only a TV without using the computer display or any other display options:
  - a. In the new window, click **TV** so that a red check mark appears directly on top of the TV icon.
  - b. Ensure that the settings are correct.



8. If you want to use a TV and the computer display at the same time:
  - a. In the new window, click **Intel (R) Dual Display Clone** and ensure that one of the devices listed is a TV.
  - b. Click **Device Settings**.
  - c. In the new window, ensure that the display resolution settings are correct.
9. Click **Apply** to view the new settings.
10. Click **OK** to confirm the settings change.
11. Click **Yes** to keep the new settings.
12. Click **OK**.

### **Discrete Video Controller**

Use the <Fn><F8> keyboard shortcut to enable your display settings:

1. Press <Fn><F8> once to enable the TV setting only.
1. Press <Fn><F8> twice to activate the TV and the display.
1. Press <Fn><F8> three times to enable the display setting only.

---

[Back to Contents Page](#)

## Cleaning Your Computer

### Dell™ Latitude™ D610 User's Guide

- [Computer, Keyboard, and Display](#)
- [Floppy Drive](#)
- [CDs and DVDs](#)

 **CAUTION:** Before you begin any of the procedures in this section, follow the safety instructions in the *Product Information Guide*.

---

## Computer, Keyboard, and Display

 **CAUTION:** Before you clean your computer, disconnect the computer from the electrical outlet and remove any installed batteries. Clean your computer with a soft cloth dampened with water. Do not use liquid or aerosol cleaners, which may contain flammable substances.

1. Use a can of compressed air to remove dust from between the keys on the keyboard.

 **NOTICE:** To avoid damaging the computer or display, do not spray cleaning solution directly onto the display. Only use products specifically designed for cleaning LCDs, and follow the instructions that are included with the product.

1. Moisten a soft, lint-free cloth with either water or an LCD cleaner, and wipe the display until it is clean.
1. Moisten a soft, lint-free cloth with water and wipe the computer and keyboard. Do not allow water from the cloth to seep between the touch pad and the surrounding palm rest.

## Touch Pad

1. Shut down and turn off your computer, disconnect any attached devices, and disconnect them from their electrical outlets.
  2. Remove any installed batteries.
  3. Moisten a soft, lint-free cloth with water, and wipe it gently across the surface of the touch pad. Do not allow water from the cloth to seep between the touch pad and the surrounding palm rest.
- 

## Floppy Drive

 **NOTICE:** Do not attempt to clean drive heads with a swab. You might accidentally misalign the heads, which prevents the drive from operating.

Clean your floppy drive using a commercially available cleaning kit. These kits contain pretreated floppies to remove contaminants that accumulate during normal operation.

---

## CDs and DVDs

 **NOTICE:** Always use compressed air to clean the lens in the CD/DVD drive, and follow the instructions that come with the compressed air. Never touch the lens in the drive.

If you notice problems, such as skipping, with the playback quality of your CDs or DVDs, try cleaning the discs.

1. Hold the disc by its outer edge. You can also touch the inside edge of the center hole.

 **NOTICE:** To prevent damaging the surface, do not wipe in a circular motion around the disc.

2. With a soft, lint-free cloth, gently wipe the bottom of the disc (the unlabeled side) in a straight line from the center to the outer edge of the disc.

For stubborn dirt, try using water or a diluted solution of water and mild soap. You can also purchase commercial products that clean discs and provide some protection from dust, fingerprints, and scratches. Cleaning products for CDs are safe to use on DVDs.

---



[Back to Contents Page](#)

## Using the Dell Diagnostics

Dell™ Latitude™ D610 User's Guide

[Dell Diagnostics](#)

 **CAUTION:** Before you begin any of the procedures in this section, follow the safety instructions in the *Product Information Guide*.

---

### Dell Diagnostics

#### When to Use the Dell Diagnostics

If you experience a problem with your computer, perform the checks in "[Solving Problems](#)" and run the Dell Diagnostics before you contact Dell for technical assistance.

It is recommended that you print these procedures before you begin.

 **NOTICE:** The Dell Diagnostics works only on Dell™ computers.

Start the Dell Diagnostics from either your hard drive or from the optional *Drivers and Utilities* CD (also known as the *ResourceCD*).

#### Starting the Dell Diagnostics From Your Hard Drive

The Dell Diagnostics is located on a hidden diagnostic utility partition on your hard drive.

 **NOTE:** If your computer cannot display a screen image, [contact Dell](#).

1. [Shut down the computer](#).
2. If the computer is connected to a docking device (docked), undock it. See the documentation that came with your docking device for instructions.
3. Connect the computer to an electrical outlet.
4. Turn on the computer. When the DELL™ logo appears, press <F12> immediately.

 **NOTE:** If you cannot see anything on your display, hold down the mute button and press the computer's power button to begin the Dell Diagnostics. The computer automatically runs the Pre-boot System Assessment.

 **NOTE:** If you see a message stating that no diagnostics utility partition has been found, run the [Dell Diagnostics](#) from your optional *Drivers and Utilities* CD.

If you wait too long and the operating system logo appears, continue to wait until you see the Microsoft® Windows® desktop. Then [shut down your computer](#) and try again.

5. When the boot device list appears, highlight **Diagnostics** and press <Enter>.

The computer runs the Pre-boot System Assessment, a series of initial tests of your system board, keyboard, hard drive, and display.

1. During the assessment, answer any questions that appear.
1. If a failure is detected, the computer stops and beeps. To stop the assessment and restart the computer, press <n>; to continue to the next test, press <y>; to retest the component that failed, press <r>.
1. If failures are detected during the Pre-boot System Assessment, write down the error code(s) and [contact Dell](#) before continuing on to the Dell Diagnostics.

If the Pre-boot System Assessment completes successfully, you receive the message `Booting Dell Diagnostic Utility Partition. Press any key to continue.`

6. Press any key to start the Dell Diagnostics from the diagnostics utility partition on your hard drive.

#### Starting the Dell Diagnostics From the Optional Drivers and Utilities CD

1. Insert the *Drivers and Utilities* CD.

2. [Shut down](#) and restart the computer.

When the DELL logo appears, press <F12> immediately.

If you wait too long and the Windows logo appears, continue to wait until you see the Windows desktop. Then [shut down your computer](#) and try again.

 **NOTE:** The next steps change the boot sequence for one time only. On the next start-up, the computer boots according to the devices specified in system setup.

3. When the boot device list appears, highlight **CD/DVD/CD-RW Drive** and press <Enter>.
4. Select the **CD/DVD/CD-RW Drive** option from the CD boot menu.
5. Select the **Boot from CD-ROM** option from the menu that appears.
6. Type 1 to start the *ResourceCD* menu.
7. Type 2 to start the Dell Diagnostics.
8. Select **Run the 32 Bit Dell Diagnostics** from the numbered list. If multiple versions are listed, select the version appropriate for your computer.
9. When the Dell Diagnostics **Main Menu** appears, select the test you want to run.

## Dell Diagnostics Main Menu

1. After the Dell Diagnostics loads and the **Main Menu** screen appears, click the button for the option you want.

Option	Function
Express Test	Performs a quick test of devices. This test typically takes 10 to 20 minutes and requires no interaction on your part. Run <b>Express Test</b> first to increase the possibility of tracing the problem quickly.
Extended Test	Performs a thorough check of devices. This test typically takes 1 hour or more and requires you to answer questions periodically.
Custom Test	Tests a specific device. You can customize the tests you want to run.
Symptom Tree	Lists the most common symptoms encountered and allows you to select a test based on the symptom of the problem you are having.

2. If a problem is encountered during a test, a message appears with an error code and a description of the problem. Write down the error code and problem description and follow the instructions on the screen.

If you cannot resolve the error condition, [contact Dell](#).

 **NOTE:** The Service Tag for your computer is located at the top of each test screen. If you contact Dell, technical support will ask for your Service Tag.

3. If you run a test from the **Custom Test** or **Symptom Tree** option, click the applicable tab described in the following table for more information.

Tab	Function
Results	Displays the results of the test and any error conditions encountered.
Errors	Displays error conditions encountered, error codes, and the problem description.
Help	Describes the test and may indicate requirements for running the test.
Configuration	Displays your hardware configuration for the selected device.  The Dell Diagnostics obtains configuration information for all devices from system setup, memory, and various internal tests, and it displays the information in the device list in the left pane of the screen. The device list may not display the names of all the components installed on your computer or all devices attached to your computer.
Parameters	Allows you to customize the test by changing the test settings.

4. When the tests are completed, if you are running the Dell Diagnostics from the optional *Drivers and Utilities* CD, remove the CD.
5. When the tests are complete, close the test screen to return to the **Main Menu** screen. To exit the Dell Diagnostics and restart the computer, close the **Main Menu** screen.



[Back to Contents Page](#)

## Using the Display

### Dell™ Latitude™ D610 User's Guide

- [Adjusting Brightness](#)
  - [Switching the Video Image](#)
  - [Setting Display Resolution and Refresh Rate](#)
  - [Dual Independent Display Mode](#)
  - [Swapping Primary and Secondary Displays](#)
- 

## Adjusting Brightness

When a Dell™ computer is running on battery power, you can conserve power by setting the brightness to the lowest comfortable setting by pressing <Fn> and the up- or down-arrow key on the keyboard.

 **NOTE:** Brightness key combinations only affect the display on your portable computer, not monitors or projectors that you attach to your portable computer or docking device. If your computer is connected to an external monitor and you try to change the brightness level, the Brightness Meter may appear, but the brightness level on the external device does not change.

You can press the following keys to adjust display brightness:

1. Press <Fn> and the up-arrow key to increase brightness on the integrated display only (not on an external monitor).
  1. Press <Fn> and the down-arrow key to decrease brightness on the integrated display only (not on an external monitor).
- 

## Switching the Video Image

When you start the computer with an external device (such as an external monitor or projector) attached and turned on, the image may appear on either the computer display or the external device.

Press <Fn><F8> to switch the video image between the display only, the external device only, or the display and the external device simultaneously.

---

## Setting Display Resolution and Refresh Rate

To display a program at a specific resolution, both the graphics card and the display must support the program, and the necessary video drivers must be installed.

Before you change any of the default display settings, make a note of the default settings for future reference.

 **NOTE:** Use only the Dell-installed video drivers, which are designed to offer the best performance with your Dell-installed operating system.

If you choose a resolution or color palette that is higher than the display supports, the settings adjust automatically to the closest supported values.

1. Click the **Start** button and click **Control Panel**.
2. Under **Pick a category**, click **Appearance and Themes**.
3. Under **Pick a task...**, click the area you want to change, or under **or pick a Control Panel icon**, click **Display**.
4. In the Display Properties window, click the **Settings** tab.
5. Try different settings for **Color quality** and **Screen resolution**.

 **NOTE:** As the resolution increases, icons and text appear smaller on the screen.

If the video resolution setting is higher than that supported by the display, the computer enters pan mode. In pan mode, the entire screen cannot be displayed at one time. For example, the taskbar that usually appears at the bottom of the desktop may no longer be visible. To view the rest of the screen, use the touch pad or track stick to pan up, down, left, and right.

 **NOTICE:** You can damage an external monitor by using an unsupported refresh rate. Before adjusting the refresh rate on an external monitor, see the user's guide for the monitor.

---

## Dual Independent Display Mode

You can attach an external monitor or projector to your computer and use it as an extension of your display (known as "dual independent display" or

"extended desktop" mode). This mode allows you to use both screens independently and drag objects from one screen to the other, effectively doubling the amount of viewable work space.

1. Connect the external monitor, TV, or projector to the computer.
2. Under **Pick a category**, click **Appearance and Themes**.
3. Under **Pick a task...**, click the area you want to change, or under **or pick a Control Panel icon**, click **Display**.
4. In the **Display Properties** window, click the **Settings** tab.

 **NOTE:** If you choose a resolution or color palette that is higher than the display supports, the settings adjust automatically to the closest supported values. For more information, see your operating system documentation.

5. Click the monitor 2 icon, click the **Extend my Windows desktop...** check box, and then click **Apply**.
6. Change **Screen Area** to the appropriate sizes for both displays and click **Apply**.
7. If prompted to restart the computer, click **Apply the new color setting without restarting** and click **OK**.
8. If prompted, click **OK** to resize your desktop.
9. If prompted, click **Yes** to keep the settings.
10. Click **OK** to close the **Display Properties** window.

To disable dual independent display mode:

1. Click the **Settings** tab in the **Display Properties** window.
2. Click the monitor 2 icon, uncheck the **Extend my Windows desktop...** option, and then click **Apply**.

If necessary, press <Fn><F8> to bring the screen image back to the computer display.

---

## Swapping Primary and Secondary Displays

To swap your primary and secondary display designations (for example, to use your external monitor as your primary display after docking):

1. Click the **Start** button and click **Control Panel**.
2. Under **Pick a category**, click **Appearance and Themes**.
3. Under **Pick a task...**, click the area you want to change, or under **or pick a Control Panel icon**, click **Display**.
4. Click the **Settings** tab→ **Advanced**→ **Displays** tab.

See the documentation that came with your video card for additional information.

---

[Back to Contents Page](#)



[Back to Contents Page](#)

## Reinstalling Software

Dell™ Latitude™ D610 User's Guide

- [Drivers](#)
- [Resolving Software and Hardware Incompatibilities](#)
- [Using Microsoft® Windows® XP System Restore](#)
- [Reinstalling Microsoft® Windows® XP](#)

 **NOTE:** The *Drivers and Utilities* CD and the *Operating System* CD are optional and may not ship with your computer.

---

### Drivers

#### What Is a Driver?

A driver is a program that controls a device such as a printer, mouse, or keyboard. All devices require a driver program.

A driver acts like a translator between the device and any other programs that use the device. Each device has its own set of specialized commands that only its driver recognizes.

Dell ships your computer to you with required drivers already installed—no further installation or configuration is needed.

 **NOTICE:** The *Drivers and Utilities* CD may contain drivers for operating systems that are not on your computer. Ensure that you are installing software appropriate for your operating system.

Many drivers, such as the keyboard driver, come with your Microsoft® Windows® operating system. You may need to install drivers if you:

- 1 Upgrade your operating system.
- 1 Reinstall your operating system.
- 1 Connect or install a new device.

#### Identifying Drivers

If you experience a problem with any device, identify whether the driver is the source of your problem and, if necessary, update the driver.

1. Click the **Start** button and click **Control Panel**.
2. Under **Pick a Category**, click **Performance and Maintenance**.
3. Click **System**.
4. In the **System Properties** window, click the **Hardware** tab.
5. Click **Device Manager**.
6. Scroll down the list to see if any device has an exclamation point (a yellow circle with a **!**) on the device icon.

If an exclamation point is next to the device name, you may need to [reinstall the driver](#) or install a new driver.

#### Reinstalling Drivers and Utilities

 **NOTICE:** The Dell Support website at [support.dell.com](http://support.dell.com) and the optional *Drivers and Utilities* CD provide approved drivers for Dell™ computers. If you install drivers obtained from other sources, your computer might not work correctly.

#### Using Windows XP Device Driver Rollback

If a problem occurs on your computer after you install or update a driver, use Windows XP Device Driver Rollback to replace the driver with the previously installed version.

1. Click the **Start** button and click **Control Panel**.
2. Under **Pick a Category**, click **Performance and Maintenance**.

3. Click **System**.
4. In the **System Properties** window, click the **Hardware** tab.
5. Click **Device Manager**.
6. Right-click the device for which the new driver was installed and click **Properties**.
7. Click the **Drivers** tab.
8. Click **Roll Back Driver**.

If Device Driver Rollback does not resolve the problem, then use [System Restore](#) to return your computer to the operating state that existed before you installed the new driver.

## Using the Optional Drivers and Utilities CD

If using Device Driver Rollback or [System Restore](#) does not resolve the problem, then reinstall the driver from the *Drivers and Utilities* CD (also known as the *ResourceCD*).

1. Save and close any open files, and exit any open programs.
2. Insert the *Drivers and Utilities* CD.

In most cases, the CD starts running automatically. If it does not, start Windows Explorer, click your CD drive directory to display the CD contents, and then double-click the **autorcd.exe** file. The first time that you run the CD, it might prompt you to install setup files. Click **OK**, and follow the instructions on the screen to continue.

3. From the **Language** drop-down menu in the toolbar, select your preferred language for the driver or utility (if available). A welcome screen appears.
4. Click **Next**.

The CD automatically scans your hardware to detect drivers and utilities used by your computer.

5. After the CD completes the hardware scan, you can also detect other drivers and utilities. Under **Search Criteria**, select the appropriate categories from the **System Model**, **Operating System**, and **Topic** drop-down menus.

A link or links appear(s) for the specific drivers and utilities used by your computer.

6. Click the link of a specific driver or utility to display information about the driver or utility that you want to install.
7. Click the **Install** button (if present) to begin installing the driver or utility. At the welcome screen, follow the screen prompts to complete the installation.

If no **Install** button is present, automatic installation is not an option. For installation instructions, either see the appropriate instructions in the following subsections, or click **Extract**, follow the extracting instructions, and then read the readme file.

If instructed to navigate to the driver files, click the CD directory on the driver information window to display the files associated with that driver.

## Manually Reinstalling Drivers

 **NOTE:** If you are reinstalling an infrared sensor driver, you must first enable the infrared sensor in [system setup](#) before continuing with the driver installation.

1. After extracting the driver files to your hard drive as described in the previous section, click the **Start** button and right-click **My Computer**.
2. Click **Properties**.
3. Click the **Hardware** tab and click **Device Manager**.
4. Double-click the type of device for which you are installing the driver (for example, **Modems** or **Infrared devices**).
5. Double-click the name of the device for which you are installing the driver.
6. Click the **Driver** tab and click **Update Driver**.
7. Click **Install from a list or specific location (Advanced)** and click **Next**.
8. Click **Browse** and browse to the location to which you previously extracted the driver files.

9. When the name of the appropriate driver appears, click **Next**.
  10. Click **Finish** and restart your computer.
- 

## Resolving Software and Hardware Incompatibilities

If a device is either not detected during the operating system setup or is detected but incorrectly configured, you can use the Hardware Troubleshooter to resolve the incompatibility:

1. Click the **Start** button and click **Help and Support**.
  2. Type `hardware troubleshooter` in the **Search** field and click the arrow to start the search.
  3. Click **Hardware Troubleshooter** in the **Search Results** list.
  4. In the **Hardware Troubleshooter** list, click **I need to resolve a hardware conflict on my computer**, and click **Next**.
- 

## Using Microsoft® Windows® XP System Restore

The Microsoft® Windows® XP operating system provides System Restore to allow you to return your computer to an earlier operating state (without affecting data files) if changes to the hardware, software, or other system settings have left the computer in an undesirable operating state. See the Windows Help and Support Center for information on using System Restore.

 **NOTICE:** Make regular backups of your data files. System Restore does not monitor your data files or recover them.

 **NOTE:** The procedures in this document were written for the Windows default view, so they may not work if you set your Dell™ computer to the Windows Classic view.

## Creating a Restore Point

1. Click the **Start** button and click **Help and Support**.
2. Click **System Restore**.
3. Follow the instructions on the screen.

## Restoring the Computer to an Earlier Operating State

 **NOTICE:** Before you restore the computer to an earlier operating state, save and close any open files and exit any open programs. Do not alter, open, or delete any files or programs until the system restoration is complete.

1. Click the **Start** button, point to **All Programs**→ **Accessories**→ **System Tools**, and then click **System Restore**.
2. Ensure that **Restore my computer to an earlier time** is selected and click **Next**.
3. Click a calendar date to which you want to restore your computer.

The **Select a Restore Point** screen provides a calendar that allows you to see and select restore points. All calendar dates with available restore points appear in boldface type.

4. Select a restore point and click **Next**.

If a calendar date has only one restore point, then that restore point is automatically selected. If two or more restore points are available, click the restore point that you prefer.

5. Click **Next**.

The **Restoration Complete** screen appears after System Restore finishes collecting data and then the computer restarts.

6. After the computer restarts, click **OK**.

To change the restore point, you can either repeat the steps using a different restore point, or you can undo the restoration.

## Undoing the Last System Restore

 **NOTICE:** Before you undo the last system restore, save and close all open files and exit any open programs. Do not alter, open, or delete any files or programs until the system restoration is complete.

1. Click the **Start** button, point to **All Programs**→ **Accessories**→ **System Tools**, and then click **System Restore**.
2. Click **Undo my last restoration** and click **Next**.
3. Click **Next**.

The **System Restore** screen appears and the computer restarts.

4. After the computer restarts, click **OK**.

## Enabling System Restore

If you reinstall Windows XP with less than 200 MB of free hard-disk space available, System Restore is automatically disabled. To see if System Restore is enabled:

1. Click the **Start** button and click **Control Panel**.
2. Click **Performance and Maintenance**.
3. Click **System**.
4. Click the **System Restore** tab.
5. Ensure that **Turn off System Restore** is unchecked.

---

## Reinstalling Microsoft® Windows® XP

 **NOTICE:** You must use Windows XP Service Pack 1 (SP1) or later when you reinstall Windows XP.

### Before You Begin

If you are considering reinstalling the Windows XP operating system to correct a problem with a newly installed driver, first try using Windows XP [Device Driver Rollback](#). If Device Driver Rollback does not resolve the problem, then use [System Restore](#) to return your operating system to the operating state it was in before you installed the new device driver.

 **NOTICE:** Before performing the installation, back up all data files on your primary hard drive. For conventional hard drive configurations, the primary hard drive is the first drive detected by the computer.

To reinstall Windows XP, you need the following items:

- 1 Dell™ *Operating System* CD
- 1 Dell *Drivers and Utilities* CD

 **NOTE:** The optional *Drivers and Utilities* CD contains drivers that were installed during assembly of the computer. Use the *Drivers and Utilities* CD to load any required drivers.

## Reinstalling Windows XP

To reinstall Windows XP, perform all the steps in the following sections in the order in which they are listed.

The reinstallation process can take 1 to 2 hours to complete. After you reinstall the operating system, you must also reinstall the device drivers, virus protection program, and other software.

 **NOTICE:** The *Operating System* CD provides options for reinstalling Windows XP. The options can overwrite files and possibly affect programs installed on your hard drive. Therefore, do not reinstall Windows XP unless a Dell technical support representative instructs you to do so.

 **NOTICE:** To prevent conflicts with Windows XP, disable any virus protection software installed on your computer before you reinstall Windows XP. See the documentation that came with the software for instructions.

## Booting From the Optional Operating System CD

1. Save and close any open files and exit any open programs.
2. Insert the *Operating System* CD. Click **Exit** if the **Install Windows XP** message appears.
3. Restart the computer.
4. Press <F12> immediately after the DELL™ logo appears.

If the operating system logo appears, wait until you see the Windows desktop, and then shut down the computer and try again.

5. Press the arrow keys to select **CD-ROM**, and press <Enter>.
6. When the **Press any key to boot from CD** message appears, press any key.

## Windows XP Setup

1. When the **Windows XP Setup** screen appears, press <Enter> to select **To set up Windows now**.
2. Read the information on the **Microsoft Windows Licensing Agreement** screen, and press <F8> to accept the license agreement.
3. If your computer already has Windows XP installed and you want to recover your current Windows XP data, type **r** to select the repair option, and remove the CD.
4. If you want to install a new copy of Windows XP, press <Esc> to select that option.
5. Press <Enter> to select the highlighted partition (recommended), and follow the instructions on the screen.

The **Windows XP Setup** screen appears, and the operating system begins to copy files and install the devices. The computer automatically restarts multiple times.

 **NOTE:** The time required to complete the setup depends on the size of the hard drive and the speed of your computer.

 **NOTICE:** Do not press any key when the following message appears: **Press any key to boot from the CD**.

6. When the **Regional and Language Options** screen appears, select the settings for your location and click **Next**.
7. Enter your name and organization (optional) in the **Personalize Your Software** screen, and click **Next**.
8. At the **Computer Name and Administrator Password** window, enter a name for your computer (or accept the one provided) and a password, and click **Next**.
9. If the **Modem Dialing Information** screen appears, enter the requested information and click **Next**.
10. Enter the date, time, and time zone in the **Date and Time Settings** window, and click **Next**.
11. If the **Networking Settings** screen appears, click **Typical** and click **Next**.
12. If you are reinstalling Windows XP Professional and you are prompted to provide further information regarding your network configuration, enter your selections. If you are unsure of your settings, accept the default selections.

Windows XP installs the operating system components and configures the computer. The computer automatically restarts.

 **NOTICE:** Do not press any key when the following message appears: **Press any key to boot from the CD**.

13. When the **Welcome to Microsoft** screen appears, click **Next**.
14. When the **How will this computer connect to the Internet?** message appears, click **Skip**.
15. When the **Ready to register with Microsoft?** screen appears, select **No, not at this time** and click **Next**.
16. When the **Who will use this computer?** screen appears, you can enter up to five users.
17. Click **Next**.
18. Click **Finish** to complete the setup, and remove the CD.

19. Reinstall the appropriate [drivers](#) with the *Drivers and Utilities* CD.

20. Reinstall your virus protection software.

21. Reinstall your programs.



 **NOTE:** To reinstall and activate your Microsoft Office or Microsoft Works Suite programs, you need the Product Key number located on the back of the Microsoft Office or Microsoft Works Suite CD sleeve.



---

[Back to Contents Page](#)

## Finding Information

### Dell™ Latitude™ D610 User's Guide

-  **NOTE:** Some features or media may be optional and may not ship with your computer. Some features or media may not be available in certain countries.
-  **NOTE:** Additional information may ship with your computer.

What Are You Looking For?	Find It Here
<ul style="list-style-type: none"> <li>1 A diagnostic program for my computer</li> <li>1 Drivers for my computer</li> <li>1 My device documentation</li> <li>1 Notebook System Software (NSS)</li> </ul>	<p><b>Drivers and Utilities CD (also known as ResourceCD)</b></p> <p><b>NOTE:</b> The <i>Drivers and Utilities</i> CD may be optional and may not ship with your computer.</p> <p>Documentation and drivers are already installed on your computer. You can use the CD to reinstall drivers or utilities or to run the Dell Diagnostics.</p>  <p>Readme files may be included on your CD to provide last-minute updates about technical changes to your computer or advanced technical-reference material for technicians or experienced users.</p> <p><b>NOTE:</b> Drivers and documentation updates can be found at <a href="http://support.dell.com">support.dell.com</a>.</p>
<ul style="list-style-type: none"> <li>1 How to set up my computer</li> <li>1 Basic troubleshooting information</li> <li>1 How to run the Dell Diagnostics</li> </ul>	<p><b>Quick Reference Guide</b></p> <p><b>NOTE:</b> This document may be optional and may not ship with your computer.</p>  <p><b>NOTE:</b> This document is available as a PDF at <a href="http://support.dell.com">support.dell.com</a>.</p>
<ul style="list-style-type: none"> <li>1 Warranty information</li> <li>1 Terms and Conditions (U.S. only)</li> <li>1 Safety instructions</li> <li>1 Regulatory information</li> <li>1 Ergonomics information</li> <li>1 End User License Agreement</li> </ul>	<p><b>Dell™ Product Information Guide</b></p> 
<ul style="list-style-type: none"> <li>1 Service Tag and Express Service Code</li> <li>1 Microsoft Windows License Label</li> </ul>	<p><b>Service Tag and Microsoft® Windows® License</b></p> <p>These labels are located on your computer.</p> <ul style="list-style-type: none"> <li>1 Use the Service Tag to identify your computer when you use <a href="http://support.dell.com">support.dell.com</a> or contact technical support.</li> </ul>

	 <p>1 Enter the Express Service Code to direct your call when contacting technical support.</p>
<ul style="list-style-type: none"> <li>1 Solutions — Troubleshooting hints and tips, articles from technicians, and online courses, frequently asked questions</li> <li>1 Community — Online discussion with other Dell customers</li> <li>1 Upgrades — Upgrade information for components, such as memory, the hard drive, and the operating system</li> <li>1 Customer Care — Contact information, service call and order status, warranty, and repair information</li> <li>1 Service and support — Service call status and support history, service contract, online discussions with technical support</li> <li>1 Reference — Computer documentation, details on my computer configuration, product specifications, and white papers</li> <li>1 Downloads — Certified drivers, patches, and software updates</li> <li>1 Notebook System Software (NSS)— If you reinstall the operating system for your computer, you should also reinstall the NSS utility. NSS provides critical updates for your operating system and <b>support for Dell™ 3.5-inch USB floppy drives, Intel® Pentium® M processors, optical drives, and USB devices.</b> NSS is necessary for correct operation of your Dell computer. The software automatically detects your computer and operating system and installs the updates appropriate for your configuration.</li> </ul>	<p><b>Dell Support Website — <a href="http://support.dell.com">support.dell.com</a></b></p> <p><b>NOTE:</b> Select your region or business segment to view the appropriate support site.</p> <p>To download Notebook System Software:</p> <ul style="list-style-type: none"> <li>1. Go to <b>support.dell.com</b>, select your region or business segment, and enter your Service Tag.</li> <li>2. <b>Select Drivers &amp; Downloads</b> and click <b>Go</b>.</li> <li>3. Click your operating system and search for the keyword <i>Notebook System Software</i>.</li> </ul> <p><b>NOTE:</b> The <a href="http://support.dell.com">support.dell.com</a> user interface may vary depending on your selections.</p>
<ul style="list-style-type: none"> <li>1 Software upgrades and troubleshooting hints — Frequently asked questions, hot topics, and general health of your computing environment</li> </ul>	<p><b>Dell Support Utility</b></p> <p>The Dell Support Utility is an automated upgrade and notification system installed on your computer. This support provides real-time health scans of your computing environment, software updates, and relevant self-support information. Access the Dell Support Utility from the  icon in the taskbar. For more information, see <a href="#">Dell Support Utility</a>.</p>
<ul style="list-style-type: none"> <li>1 How to use Windows XP</li> <li>1 How to work with programs and files</li> <li>1 How to personalize my desktop</li> </ul>	<p><b>Windows Help and Support Center</b></p> <ul style="list-style-type: none"> <li>1. Click the <b>Start</b> button and click <b>Help and Support</b>.</li> <li>2. Type a word or phrase that describes your problem and click the arrow icon.</li> <li>3. Click the topic that describes your problem.</li> <li>4. Follow the instructions on the screen.</li> </ul>
<ul style="list-style-type: none"> <li>1 Information on network activity, the Power Management Wizard, hotkeys, and other items controlled by Dell QuickSet</li> </ul>	<p><b>Dell QuickSet Help</b></p> <p>To view <i>Dell QuickSet Help</i>, right-click the  icon in the Microsoft® Windows® taskbar.</p>
<ul style="list-style-type: none"> <li>1 How to reinstall my operating system</li> </ul>	<p><b>Operating System CD</b></p> <p><b>NOTE:</b> The <i>Operating System</i> CD may be optional and may not ship with your computer.</p> <p>The operating system is already installed on your computer. To reinstall your operating system, use the <i>Operating System</i> CD. See <a href="#">Reinstalling Microsoft® Windows® XP</a>.</p>



After you reinstall your operating system, use the *Drivers and Utilities CD (ResourceCD)* to reinstall drivers for the devices that came with your computer.



[Your operating system product key label is located on your computer.](#)

**NOTE:** The color of your CD varies based on the operating system you ordered.

---

[Back to Contents Page](#)

[Back to Contents Page](#)

## Getting Help

### Dell™ Latitude™ D610 User's Guide

- [Technical Assistance](#)
  - [Problems With Your Order](#)
  - [Product Information](#)
  - [Returning Items for Warranty Repair or Credit](#)
  - [Before You Call](#)
  - [Contacting Dell](#)
- 

## Technical Assistance

If you need help with a technical problem, Dell is ready to assist you.

 **CAUTION:** If you need to remove the computer covers, first disconnect the computer power and modem cables from all electrical outlets.

1. Complete the procedures in [Solving Problems](#).
2. Run the Dell Diagnostics (see [Using the Dell Diagnostics](#)).
3. Make a copy of the [Diagnostics Checklist](#) and fill it out.
4. Use Dell's extensive suite of online services available at Dell Support ([support.dell.com](http://support.dell.com)) for help with installation and troubleshooting procedures.
5. If the preceding steps have not resolved the problem, contact Dell.

**NOTE:** Call technical support from a telephone near or at the computer so that technical support can assist you with any necessary procedures.

**NOTE:** Dell's Express Service Code system may not be available in all countries.

When prompted by Dell's automated telephone system, enter your Express Service Code to route the call directly to the proper support personnel. If you do not have an Express Service Code, open the **Dell Accessories** folder, double-click the **Express Service Code** icon, and follow the directions.

For instructions on using the technical support service, see "[Technical Support Service](#)."

**NOTE:** Some of the following services are not always available in all locations outside the continental U.S. Call your local Dell representative for information on availability.

## Online Services

You can access Dell Support at [support.dell.com](http://support.dell.com). Select your region on the **WELCOME TO DELL SUPPORT** page, and fill in the requested details to access help tools and information.

You can contact Dell electronically using the following addresses:

- 1 World Wide Web

[www.dell.com/](http://www.dell.com/)

[www.dell.com/ap/](http://www.dell.com/ap/) (Asian/Pacific countries only)

[www.dell.com/jp](http://www.dell.com/jp/) (Japan only)

[www.euro.dell.com](http://www.euro.dell.com) (Europe only)

[www.dell.com/la/](http://www.dell.com/la/) (Latin American countries)

[www.dell.ca](http://www.dell.ca) (Canada only)

- 1 Anonymous file transfer protocol (FTP)

[ftp.dell.com/](http://ftp.dell.com/)

Log in as user: `anonymous`, and use your e-mail address as your password.

- 1 Electronic Support Service

[mobile\\_support@us.dell.com](mailto:mobile_support@us.dell.com)

[support@us.dell.com](mailto:support@us.dell.com)

apsupport@dell.com (Asian/Pacific countries only)

**support.jp.dell.com** (Japan only)

**support.euro.dell.com** (Europe only)

1 Electronic Quote Service

apmarketing@dell.com (Asian/Pacific countries only)

sales\_canada@dell.com (Canada only)

## AutoTech Service

Dell's automated technical support service—AutoTech—provides recorded answers to the questions most frequently asked by Dell customers about their portable and desktop computers.

When you call AutoTech, use your touch-tone telephone to select the subjects that correspond to your questions.

The AutoTech service is available 24 hours a day, 7 days a week. You can also access this service through the technical support service. For the telephone number to call, see the [contact numbers](#) for your region.

## Automated Order-Status Service

To check on the status of any Dell™ products that you have ordered, you can go to [support.dell.com](#), or you can call the automated order-status service. A recording prompts you for the information needed to locate and report on your order. For the telephone number to call, see the [contact numbers](#) for your region.

## Technical Support Service

Dell's technical support service is available 24 hours a day, 7 days a week, to answer your questions about Dell hardware. Our technical support staff uses computer-based diagnostics to provide fast, accurate answers.

To contact Dell's technical support service, see [Getting Help](#) and then call the number for your country as listed in "[Contacting Dell](#)."

---

## Problems With Your Order

If you have a problem with your order, such as missing parts, wrong parts, or incorrect billing, contact Dell for customer assistance. Have your invoice or packing slip handy when you call. For the telephone number to call, see the [contact numbers](#) for your region.

---

## Product Information

If you need information about additional products available from Dell, or if you would like to place an order, visit the Dell website at [www.dell.com](#). For the telephone number to call to speak to a sales specialist, see the [contact numbers](#) for your region.

---

## Returning Items for Warranty Repair or Credit

Prepare all items being returned, whether for repair or credit, as follows:

1. Call Dell to obtain a Return Material Authorization Number, and write it clearly and prominently on the outside of the box.  
For the telephone number to call, see the [contact numbers](#) for your region.
2. Include a copy of the invoice and a letter describing the reason for the return.
3. Include a copy of the [Diagnostics Checklist](#) indicating the tests you have run and any error messages reported by the Dell Diagnostics.
4. Include any accessories that belong with the item(s) being returned (power cables, software floppy disks, guides, and so on) if the return is for credit.
5. Pack the equipment to be returned in the original (or equivalent) packing materials.

You are responsible for paying shipping expenses. You are also responsible for insuring any product returned, and you assume the risk of loss during shipment to Dell. Collect On Delivery (C.O.D.) packages are not accepted.

Returns that are missing any of the preceding requirements will be refused at Dell's receiving dock and returned to you.

## Before You Call

**NOTE:** Have your Express Service Code ready when you call. The code helps Dell's automated-support telephone system direct your call more efficiently.

Remember to fill out the [Diagnostics Checklist](#). If possible, turn on your computer before you call Dell for technical assistance and call from a telephone at or near the computer. You may be asked to type some commands at the keyboard, relay detailed information during operations, or try other troubleshooting steps possible only at the computer itself. Ensure that the computer documentation is available.

 **CAUTION:** Before working inside your computer, read the safety instructions in your *Product Information Guide*.

<b>Diagnostics Checklist</b>
Name:
Date:
Address:
Phone number:
Service Tag (bar code on the back of the computer):
Express Service Code:
Return Material Authorization Number (if provided by Dell support technician):
Operating system and version:
Devices:
Expansion cards:
Are you connected to a network? Yes No
Network, version, and network adapter:
Programs and versions:
See your operating system documentation to determine the contents of the system's start-up files. If the computer is connected to a printer, print each file. Otherwise, record the contents of each file before calling Dell.
Error message, beep code, or diagnostic code:
Description of problem and troubleshooting procedures you performed:

## Contacting Dell

To contact Dell electronically, you can access the following websites:

- 1 [www.dell.com](http://www.dell.com)
- 1 [support.dell.com](http://support.dell.com) (support)

For specific web addresses for your country, find the appropriate country section in the table below.

 **NOTE:** Toll-free numbers are for use within the country for which they are listed.

 **NOTE:** In certain countries, support specific to Dell XPS™ portable computers is available at a separate telephone number listed for participating countries. If you do not see a telephone number listed that is specific for XPS portable computers, you may contact Dell through the support number listed and your call will be routed appropriately.

When you need to contact Dell, use the electronic addresses, telephone numbers, and codes provided in the following table. If you need assistance in determining which codes to use, contact a local or an international operator.

Country (City) International Access Code Country Code City Code	Department Name or Service Area, Website and E-Mail Address	Area Codes, Local Numbers, and Toll-Free Numbers
Anguilla	General Support	toll-free: 800-335-0031
Antigua and Barbuda	General Support	1-800-805-5924
Argentina (Buenos Aires)  International Access Code: 00 Country Code: 54 City Code: 11	Website: <a href="http://www.dell.com.ar">www.dell.com.ar</a>	
	E-mail: <a href="mailto:us_latin_services@dell.com">us_latin_services@dell.com</a>	
	E-mail for desktop and portable computers: <a href="mailto:la-techsupport@dell.com">la-techsupport@dell.com</a>	
	E-mail for servers and EMC® storage products: <a href="mailto:la_enterprise@dell.com">la_enterprise@dell.com</a>	
	Customer Care	toll-free: 0-800-444-0730
	Hardware and Warranty Support	toll-free: 0-800-444-0733

	Hardware And Warranty Support Services	toll-free: 0-800-444-0724
	Sales	0-810-444-3355
<b>Aruba</b>	General Support	toll-free: 800-1578
<b>Australia (Sydney)</b>	Website: support.ap.dell.com	
International Access Code: 0011	E-mail: support.ap.dell.com/contactus	
Country Code: 61	General Support	13DELL-133355
City Code: 2		
<b>Austria (Vienna)</b>	Website: support.euro.dell.com	
	E-mail: tech_support_central_europe@dell.com	
	Home/Small Business Sales	0820 240 530 00
	Home/Small Business Fax	0820 240 530 49
	Home/Small Business Customer Care	0820 240 530 14
	Preferred Accounts/Corporate Customer Care	0820 240 530 16
	Support for XPS portable computers only	0820 240 530 81
	Home/Small Business Support for all other Dell computers	0820 240 530 14
	Preferred Accounts/Corporate Support	0660 8779
Switchboard	0820 240 530 00	
<b>Bahamas</b>	General Support	toll-free: 1-866-278-6818
<b>Barbados</b>	General Support	1-800-534-3066
<b>Belgium (Brussels)</b>	Website: support.euro.dell.com	
	Hardware And Warranty Support for XPS portable computers only	02 481 92 96
	Hardware And Warranty Support for all other Dell computers	02 481 92 88
	Hardware And Warranty Support Fax	02 481 92 95
	Customer Care	02 713 15 65
	Corporate Sales	02 481 91 00
	Fax	02 481 92 99
	Switchboard	02 481 91 00
<b>Bermuda</b>	General Support	1-800-342-0671
<b>Bolivia</b>	General Support	toll-free: 800-10-0238
<b>Brazil</b>	Website: www.dell.com/br	
	Customer Support, Hardware and Warranty Support	0800 90 3355
	Hardware and Warranty Support Fax	51 481 5470
	Customer Care Fax	51 481 5480
	Sales	0800 90 3390
<b>British Virgin Islands</b>	General Support	toll-free: 1-866-278-6820
<b>Brunei</b>	Hardware and Warranty Support (Penang, Malaysia)	604 633 4966
	Customer Care (Penang, Malaysia)	604 633 4888
	Transaction Sales (Penang, Malaysia)	604 633 4955
<b>Canada (North York, Ontario)</b>	Online Order Status: www.dell.ca/ostatus	
	AutoTech (automated Hardware and Warranty Support)	toll-free: 1-800-247-9362
	Customer Service (Home Sales/Small Business)	toll-free: 1-800-847-4096
	Customer Service (med./large business, government)	toll-free: 1-800-326-9463
	Customer Service (printers, projectors, televisions, handhelds, digital jukebox, and wireless)	toll-free: 1-800-847-4096
	Hardware Warranty Support (Home Sales/Small Business)	toll-free: 1-800-906-3355
	Hardware Warranty Support (med./large bus., government)	toll-free: 1-800-387-5757
	Hardware Warranty Support (printers, projectors, televisions, handhelds, digital jukebox, and wireless)	1-877-335-5767
	Sales (Home Sales/Small Business)	toll-free: 1-800-387-5752
Sales (med./large bus., government)	toll-free: 1-800-387-5755	
Spare Parts Sales & Extended Service Sales	1 866 440 3355	
<b>Cayman Islands</b>	General Support	1-800-805-7541
<b>Chile (Santiago)</b>		
Country Code: 56	Sales and Customer Support	toll-free: 1230-020-4823
City Code: 2		
	Hardware and Warranty Support website: support.dell.com.cn	

China (Xiamen) Country Code: 86 City Code: 592	Hardware and Warranty Support E-mail: cn_support@dell.com	
	Customer Care E-mail: customer_cn@dell.com	
	Hardware and Warranty Support Fax	592 818 1350
	Hardware and Warranty Support (Dell™ Dimension™ and Inspiron)	toll-free: 800 858 2968
	Hardware and Warranty Support (OptiPlex™, Latitude™, and Dell Precision™)	toll-free: 800 858 0950
	Hardware and Warranty Support (servers and storage)	toll-free: 800 858 0960
	Hardware and Warranty Support (projectors, PDAs, switches, routers, and so on)	toll-free: 800 858 2920
	Hardware and Warranty Support (printers)	toll-free: 800 858 2311
	Customer Care	toll-free: 800 858 2060
	Customer Care Fax	592 818 1308
	Home and Small Business	toll-free: 800 858 2222
	Preferred Accounts Division	toll-free: 800 858 2557
	Large Corporate Accounts GCP	toll-free: 800 858 2055
	Large Corporate Accounts Key Accounts	toll-free: 800 858 2628
	Large Corporate Accounts North	toll-free: 800 858 2999
	Large Corporate Accounts North Government and Education	toll-free: 800 858 2955
	Large Corporate Accounts East	toll-free: 800 858 2020
	Large Corporate Accounts East Government and Education	toll-free: 800 858 2669
	Large Corporate Accounts Queue Team	toll-free: 800 858 2572
	Large Corporate Accounts South	toll-free: 800 858 2355
Large Corporate Accounts West	toll-free: 800 858 2811	
Large Corporate Accounts Spare Parts	toll-free: 800 858 2621	
<b>Colombia</b>	General Support	980-9-15-3978
<b>Costa Rica</b>	General Support	0800-012-0435
Czech Republic (Prague) International Access Code: 00 Country Code: 420	Website: support.euro.dell.com	
	E-mail: czech_dell@dell.com	
	Hardware and Warranty Support	22537 2727
	Customer Care	22537 2707
	Fax	22537 2714
	Hardware and Warranty Fax	22537 2728
Denmark (Copenhagen) International Access Code: 00 Country Code: 45	Switchboard	22537 2711
	Website: support.euro.dell.com	
	Hardware and Warranty Support for XPS portable computers only	7010 0074
	Hardware and Warranty Support for all other Dell computers	7023 0182
	Customer Care (Relational)	7023 0184
	Home/Small Business Customer Care	3287 5505
	Switchboard (Relational)	3287 1200
	Switchboard Fax (Relational)	3287 1201
Dominica	Switchboard (Home/Small Business)	3287 5000
	Switchboard Fax (Home/Small Business)	3287 5001
<b>Dominican Republic</b>	General Support	toll-free: 1-866-278-6821
<b>Dominican Republic</b>	General Support	1-800-148-0530
<b>Ecuador</b>	General Support	toll-free: 999-119
<b>El Salvador</b>	General Support	01-899-753-0777
Finland (Helsinki) International Access Code: 990 Country Code: 358 City Code: 9	Website: support.euro.dell.com	
	Hardware and Warranty Support	09 253 313 60
	Customer Care	09 253 313 38
	Fax	09 253 313 99
	Switchboard	09 253 313 00
France (Paris) (Montpellier) International Access Code: 00	Website: support.euro.dell.com	
	Home and Small Business	
	Hardware and Warranty Support for XPS portable computers only	0825 387 129
	Hardware and Warranty Support for all other Dell computers	0825 387 270
	Customer Care	0825 823 833
	Switchboard	0825 004 700
	Switchboard (calls from outside of France)	04 99 75 40 00
Sales	0825 004 700	

Country Code: <b>33</b> City Codes: <b>(1) (4)</b>	Fax	0825 004 701
	Fax (calls from outside of France)	04 99 75 40 01
	<b>Corporate</b>	
	Hardware and Warranty Support	0825 004 719
	Customer Care	0825 338 339
	Switchboard	01 55 94 71 00
	Sales	01 55 94 71 00
	Fax	01 55 94 71 01
<b>Germany (Langen)</b> International Access Code: <b>00</b> Country Code: <b>49</b> City Code: <b>6103</b>	Website: <b>support.euro.dell.com</b>	
	E-mail: tech_support_central_europe@dell.com	
	Hardware and Warranty Support for XPS portable computers only	06103 766-7222
	Hardware and Warranty Support for all other Dell computers	06103 766-7200
	Home/Small Business Customer Care	0180-5-224400
	Global Segment Customer Care	06103 766-9570
	Preferred Accounts Customer Care	06103 766-9420
	Large Accounts Customer Care	06103 766-9560
	Public Accounts Customer Care	06103 766-9555
Switchboard	06103 766-7000	
<b>Greece</b> International Access Code: <b>00</b> Country Code: <b>30</b>	Website: <b>support.euro.dell.com</b>	
	Hardware and Warranty Support	00800-44 14 95 18
	Gold Service Hardware and Warranty Support	00800-44 14 00 83
	Switchboard	2108129810
	Gold Service Switchboard	2108129811
	Sales	2108129800
	Fax	2108129812
<b>Grenada</b>	General Support	toll-free: 1-866-540-3355
<b>Guatemala</b>	General Support	1-800-999-0136
<b>Guyana</b>	General Support	toll-free: 1-877-270-4609
<b>Hong Kong</b> International Access Code: <b>001</b> Country Code: <b>852</b>	Website: <b>support.ap.dell.com</b>	
	Hardware and Warranty Support E-mail: apsupport@dell.com	
	Hardware and Warranty Support (Dimension and Inspiron)	2969 3188
	Hardware and Warranty Support (OptiPlex, Latitude, and Dell Precision)	2969 3191
	Hardware and Warranty Support (PowerApp™, PowerEdge™, PowerConnect™, and PowerVault™)	2969 3196
	Customer Care	3416 0910
	Large Corporate Accounts	3416 0907
	Global Customer Programs	3416 0908
	Medium Business Division	3416 0912
Home and Small Business Division	2969 3105	
<b>India</b>	E-mail: india_support_desktop@dell.com india_support_notebook@dell.com india_support_Server@dell.com	
	Hardware And Warranty Support	1600338045 and 1600448046
	Sales (Large Corporate Accounts)	1600 33 8044
	Sales (Home and Small Business)	1600 33 8046
<b>Ireland (Cherrywood)</b> International Access Code: <b>16</b> Country Code: <b>353</b> City Code: <b>1</b>	Website: <b>support.euro.dell.com</b>	
	E-mail: dell_direct_support@dell.com	
	Hardware and Warranty Support for XPS portable computers only	1850 200 722
	Hardware and Warranty Support for all other Dell computers	1850 543 543
	U.K. Hardware and Warranty Support (dial within U.K. only)	0870 908 0800
	Home User Customer Care	01 204 4014
	Small Business Customer Care	01 204 4014
	U.K. Customer Care (dial within U.K. only)	0870 906 0010
	Corporate Customer Care	1850 200 982
	Corporate Customer Care (dial within U.K. only)	0870 907 4499
	Ireland Sales	01 204 4444
	U.K. Sales (dial within U.K. only)	0870 907 4000
	Fax/Sales Fax	01 204 0103
Switchboard	01 204 4444	

<b>Italy (Milan)</b> International Access Code: <b>00</b> Country Code: <b>39</b> City Code: <b>02</b>	Website: <a href="http://support.euro.dell.com">support.euro.dell.com</a>	
	<b>Home and Small Business</b>	
	Hardware and Warranty Support	02 577 826 90
	Customer Care	02 696 821 14
	Fax	02 696 821 13
	Switchboard	02 696 821 12
	<b>Corporate</b>	
	Hardware and Warranty Support	02 577 826 90
	Customer Care	02 577 825 55
	Fax	02 575 035 30
Switchboard	02 577 821	
<b>Jamaica</b>	General Support (dial from within Jamaica only)	1-800-682-3639
<b>Japan (Kawasaki)</b> International Access Code: <b>001</b> Country Code: <b>81</b> City Code: <b>44</b>	Website: <a href="http://support.jp.dell.com">support.jp.dell.com</a>	
	Hardware And Warranty Support (servers)	toll-free: 0120-198-498
	Hardware And Warranty Support outside of Japan (servers)	81-44-556-4162
	Hardware And Warranty Support (Dimension and Inspiron)	toll-free: 0120-198-226
	Hardware And Warranty Support outside of Japan (Dimension and Inspiron)	81-44-520-1435
	Hardware And Warranty Support (Dell Precision, OptiPlex, and Latitude)	toll-free: 0120-198-433
	Hardware And Warranty Support outside of Japan (Dell Precision, OptiPlex, and Latitude)	81-44-556-3894
	Hardware And Warranty Support (PDAs, projectors, printers, routers)	toll-free: 0120-981-690
	Hardware And Warranty Support outside of Japan (PDAs, projectors, printers, routers)	81-44-556-3468
	Faxbox Service	044-556-3490
	24-Hour Automated Order Service	044-556-3801
	Customer Care	044-556-4240
	Business Sales Division (up to 400 employees)	044-556-1465
	Preferred Accounts Division Sales (over 400 employees)	044-556-3433
	Large Corporate Accounts Sales (over 3500 employees)	044-556-3430
	Public Sales (government agencies, educational institutions, and medical institutions)	044-556-1469
	Global Segment Japan	044-556-3469
Individual User	044-556-1760	
Switchboard	044-556-4300	
<b>Korea (Seoul)</b> International Access Code: <b>001</b> Country Code: <b>82</b> City Code: <b>2</b>	E-mail: <a href="mailto:krsupport@dell.com">krsupport@dell.com</a>	
	Support	toll-free: 080-200-3800
	Support (Dimension, PDA, Electronics and Accessories)	toll-free: 080-200-3801
	Sales	toll-free: 080-200-3600
	Fax	2194-6202
	Switchboard	2194-6000
<b>Latin America</b>	Customer Hardware and Warranty Support (Austin, Texas, U.S.A.)	512 728-4093
	Customer Service (Austin, Texas, U.S.A.)	512 728-3619
	Fax (Hardware and Warranty Support and Customer Service) (Austin, Texas, U.S.A.)	512 728-3883
	Sales (Austin, Texas, U.S.A.)	512 728-4397
	Sales (Austin, Texas, U.S.A.)	512 728-4600
	SalesFax (Austin, Texas, U.S.A.)	or 512 728-3772
<b>Luxembourg</b> International Access Code: <b>00</b> Country Code: <b>352</b>	Website: <a href="http://support.euro.dell.com">support.euro.dell.com</a>	
	Support	342 08 08 075
	Home/Small Business Sales	+32 (0)2 713 15 96
	Corporate Sales	26 25 77 81
	Customer Care	+32 (0)2 481 91 19
Fax	26 25 77 82	
<b>Macao</b> Country Code: <b>853</b>	Hardware and Warranty Support	toll-free: 0800 105
	Customer Service (Xiamen, China)	34 160 910
	Transaction Sales (Xiamen, China)	29 693 115
<b>Malaysia (Penang)</b> International Access Code: <b>00</b>	Website: <a href="http://support.ap.dell.com">support.ap.dell.com</a>	
	Hardware And Warranty Support (Dell Precision, OptiPlex, and Latitude)	toll-free: 1 800 880 193
	Hardware And Warranty Support (Dimension, Inspiron, and Electronics and Accessories)	toll-free: 1 800 881 306



Country Code: 60	Hardware And Warranty Support (PowerApp, PowerEdge, PowerConnect, and PowerVault)	toll-free: 1800 881 386
	Customer Care	toll-free: 1800 881 306 (option 6)
City Code: 4	Transaction Sales	toll-free: 1 800 888 202
	Corporate Sales	toll-free: 1 800 888 213
Mexico International Access Code: 00 Country Code: 52	Customer Hardware And Warranty Support	001-877-384-8979 or 001-877-269-3383
	Sales	50-81-8800 or 01-800-888-3355
	Customer Service	001-877-384-8979 or 001-877-269-3383
	Main	50-81-8800 or 01-800-888-3355
Montserrat	General Support	toll-free: 1-866-278-6822
Netherlands Antilles	General Support	001-800-882-1519
Netherlands (Amsterdam) International Access Code: 00 Country Code: 31 City Code: 20	Website: <a href="http://support.euro.dell.com">support.euro.dell.com</a>	
	Hardware and Warranty Support for XPS portable computers only	020 674 45 94
	Hardware and Warranty Support for all other Dell computers	020 674 45 00
	Hardware and Warranty Support Fax	020 674 47 66
	Home/Small Business Customer Care	020 674 42 00
	Relational Customer Care	020 674 4325
	Home/Small Business Sales	020 674 55 00
	Relational Sales	020 674 50 00
	Home/Small Business Sales Fax	020 674 47 75
	Relational Sales Fax	020 674 47 50
	Switchboard	020 674 50 00
Switchboard Fax	020 674 47 50	
New Zealand International Access Code: 00	Website: <a href="http://support.ap.dell.com">support.ap.dell.com</a>	
	E-mail: <a href="mailto:support.ap.dell.com/contactus">support.ap.dell.com/contactus</a>	
Country Code: 64	General Support	0800 441 567
Nicaragua	General Support	001-800-220-1006
Norway (Lysaker) International Access Code: 00 Country Code: 47	Website: <a href="http://support.euro.dell.com">support.euro.dell.com</a>	
	Hardware and Warranty Support for XPS portable computers only	815 35 043
	Hardware and Warranty Support for all other Dell products	671 16882
	Relational Customer Care	671 17575
	Home/Small Business Customer Care	23162298
	Switchboard	671 16800
Fax Switchboard	671 16865	
Panama	General Support	001-800-507-0962
Peru	General Support	0800-50-669
Poland (Warsaw) International Access Code: 011 Country Code: 48 City Code: 22	Website: <a href="http://support.euro.dell.com">support.euro.dell.com</a>	
	E-mail: <a href="mailto:pl_support_tech@dell.com">pl_support_tech@dell.com</a>	
	Customer Service Phone	57 95 700
	Customer Care	57 95 999
	Sales	57 95 999
	Customer Service Fax	57 95 806
	Reception Desk Fax	57 95 998
	Switchboard	57 95 999
Portugal International Access Code: 00 Country Code: 351	Website: <a href="http://support.euro.dell.com">support.euro.dell.com</a>	
	Hardware and Warranty Support	707200149
	Customer Care	800 300 413
	Sales	800 300 410 or 800 300 411 or 800 300 412 or 21 422 07 10
	Fax	21 424 01 12
Puerto Rico	General Support	1-800-805-7545
St. Kitts and Nevis	General Support	toll-free: 1-877-441-4731
St. Lucia	General Support	1-800-882-1521

<b>St. Vincent and the Grenadines</b>	General Support	toll-free: 1-877-270-4609
<b>Singapore (Singapore)</b> International Access Code: 005 Country Code: 65	Website: <a href="http://support.ap.dell.com">support.ap.dell.com</a>	
	Hardware and Warranty Support (Dimension, Inspiron, and Electronics and Accessories)	toll-free: 1800 394 7430
	Hardware and Warranty Support (OptiPlex, Latitude, and Dell Precision)	toll-free: 1800 394 7488
	Hardware and Warranty Support (PowerApp, PowerEdge, PowerConnect, and PowerVault)	toll-free: 1800 394 7478
	Customer Care	toll-free: 1 800 394 7430 (option 6)
	Transaction Sales	toll-free: 1 800 394 7412
	Corporate Sales	toll-free: 1 800 394 7419
<b>Slovakia (Prague)</b> International Access Code: 00 Country Code: 421	Website: <a href="http://support.euro.dell.com">support.euro.dell.com</a>	
	E-mail: <a href="mailto:czech_dell@dell.com">czech_dell@dell.com</a>	
	Hardware and Warranty Support	02 5441 5727
	Customer Care	420 22537 2707
	Fax	02 5441 8328
	Tech Fax	02 5441 8328
	Switchboard (Sales)	02 5441 7585
<b>South Africa (Johannesburg)</b> International Access Code: 09/091 Country Code: 27 City Code: 11	Website: <a href="http://support.euro.dell.com">support.euro.dell.com</a>	
	E-mail: <a href="mailto:dell_za_support@dell.com">dell_za_support@dell.com</a>	
	Gold Queue	011 709 7713
	Hardware and Warranty Support	011 709 7710
	Customer Care	011 709 7707
	Sales	011 709 7700
	Fax	011 706 0495
	Switchboard	011 709 7700
<b>Southeast Asian and Pacific Countries</b>	Hardware and Warranty Support, Customer Service, and Sales (Penang, Malaysia)	604 633 4810
<b>Spain (Madrid)</b> International Access Code: 00 Country Code: 34 City Code: 91	Website: <a href="http://support.euro.dell.com">support.euro.dell.com</a>	
	<b>Home and Small Business</b>	
	Hardware and Warranty Support	902 100 130
	Customer Care	902 118 540
	Sales	902 118 541
	Switchboard	902 118 541
	Fax	902 118 539
	<b>Corporate</b>	
	Hardware and Warranty Support	902 100 130
	Customer Care	902 115 236
	Switchboard	91 722 92 00
	Fax	91 722 95 83
	<b>Sweden (Upplands Vasby)</b> International Access Code: 00 Country Code: 46 City Code: 8	Website: <a href="http://support.euro.dell.com">support.euro.dell.com</a>
Hardware and Warranty Support for XPS portable computers only		0771 340 340
Hardware and Warranty Support for all other Dell products		08 590 05 199
Relational Customer Care		08 590 05 642
Home/Small Business Customer Care		08 587 70 527
Employee Purchase Program (EPP) Support		20 140 14 44
Hardware and Warranty Support Fax		08 590 05 594
Sales		08 590 05 185
<b>Switzerland (Geneva)</b> International Access Code: 00 Country Code: 41 City Code: 22	Website: <a href="http://support.euro.dell.com">support.euro.dell.com</a>	
	E-mail: <a href="mailto:Tech_support_central_Europe@dell.com">Tech_support_central_Europe@dell.com</a>	
	Hardware and Warranty Support for XPS portable computers only	0848 33 88 57
	Hardware and Warranty Support (Home and Small Business) for all other Dell products	0844 811 411
	Hardware and Warranty Support (Corporate)	0844 822 844
	Customer Care (Home and Small Business)	0848 802 202
	Customer Care (Corporate)	0848 821 721
	Fax	022 799 01 90
Switchboard	022 799 01 01	
	Website: <a href="http://support.ap.dell.com">support.ap.dell.com</a>	
	E-mail: <a href="mailto:ap_support@dell.com">ap_support@dell.com</a>	

Taiwan International Access Code: <b>002</b> Country Code: <b>886</b>	Hardware and Warranty Support (OptiPlex, Latitude, Inspiron, Dimension, and Electronics and Accessories)	toll-free: 00801 86 1011
	Hardware and Warranty Support (PowerApp, PowerEdge, PowerConnect, and PowerVault)	toll-free: 00801 60 1256
	Customer Care	toll-free: 00801 60 1250 (option 5)
	Transaction Sales	toll-free: 00801 65 1228
	Corporate Sales	toll-free: 00801 651 227
Thailand International Access Code: <b>001</b> Country Code: <b>66</b>	Website: <b>support.ap.dell.com</b>	
	Hardware and Warranty Support (OptiPlex, Latitude, and Dell Precision)	toll-free: 1800 0060 07
	Hardware and Warranty Support (PowerApp, PowerEdge, PowerConnect, and PowerVault)	toll-free: 1800 0600 09
	Customer Care	toll-free: 1800 006 007 (option 7)
	Corporate Sales	toll-free: 1800 006 009
	Transaction Sales	toll-free: 1800 006 006
Trinidad/Tobago	General Support	1-800-805-8035
Turks and Caicos Islands	General Support	toll-free: 1-866-540-3355
U.K. (Bracknell) International Access Code: <b>00</b> Country Code: <b>44</b> City Code: <b>1344</b>	Website: <b>support.euro.dell.com</b>	
	Customer Care website: <b>support.euro.dell.com/uk/en/ECare/Form/Home.asp</b>	
	E-mail: <b>dell_direct_support@dell.com</b>	
	Hardware and Warranty Support (Corporate/Preferred Accounts/PAD [1000+ employees])	0870 908 0500
	Hardware and Warranty Support for XPS portable computers only	0870 366 4180
	Hardware and Warranty Support (direct and general) for all other products	0870 908 0800
	Global Accounts Customer Care	01344 373 186
	Home and Small Business Customer Care	0870 906 0010
	Corporate Customer Care	01344 373 185
	Preferred Accounts (500–5000 employees) Customer Care	0870 906 0010
	Central Government Customer Care	01344 373 193
	Local Government & Education Customer Care	01344 373 199
	Health Customer Care	01344 373 194
	Home and Small Business Sales	0870 907 4000
	Corporate/Public Sector Sales	01344 860 456
Home and Small Business Fax	0870 907 4006	
Uruguay	General Support	toll-free: 000-413-598-2521
U.S.A. (Austin, Texas) International Access Code: <b>011</b> Country Code: <b>1</b>	Automated Order-Status Service	toll-free: 1-800-433-9014
	AutoTech (portable and desktop computers)	toll-free: 1-800-247-9362
	Hardware and Warranty Support (Dell TV, Printers, and Projectors) for Relationship customers	toll-free 1-877-459-7298
	<b>Consumer (Home and Home Office) Support for all other Dell products</b>	toll-free: 1-800-624-9896
	Customer Service	toll-free: 1-800-624-9897
	Employee Purchase Program (EPP) Customers	toll-free: 1-800-695-8133
	Financial Services website: <b>www.dellfinancialservices.com</b>	
	Financial Services (lease/loans)	toll-free: 1-877-577-3355
	Financial Services (Dell Preferred Accounts [DPA])	toll-free: 1-800-283-2210
	<b>Business</b>	
	Customer Service and Support	toll-free: 1-800-456-3355
	Employee Purchase Program (EPP) Customers	toll-free: 1-800-695-8133
	Printers and Projectors Support	toll-free: 1-877-459-7298
	<b>Public (government, education, and healthcare)</b>	
	Customer Service and Support	toll-free: 1-800-456-3355
	Employee Purchase Program (EPP) Customers	toll-free: 1-800-695-8133
	Dell Sales	toll-free: 1-800-289-3355
		or toll-free: 1-800-879-3355
	Dell Outlet Store (Dell refurbished computers)	toll-free: 1-888-798-7561
	Software and Peripherals Sales	toll-free: 1-800-671-3355
Spare Parts Sales	toll-free: 1-800-357-3355	
Extended Service and Warranty Sales	toll-free: 1-800-247-4618	
Fax	toll-free: 1-800-727-8320	

	Dell Services for the Deaf, Hard-of-Hearing, or Speech-Impaired	toll-free: 1-877-DELLTTY (1-877-335-5889)
<b>U.S. Virgin Islands</b>	General Support	1-877-673-3355
<b>Venezuela</b>	General Support	8001-3605

---

[Back to Contents Page](#)

## Glossary

### Dell™ Latitude™ D610 User's Guide

Terms in this Glossary are provided for informational purposes only and may or may not describe features included with your particular computer.

---

#### A

**AC** — alternating current — The form of electricity that powers your computer when you plug the AC adapter power cable in to an electrical outlet.

**ACPI** — advanced configuration and power interface — A power management specification that enables Microsoft® Windows® operating systems to put a computer in standby or hibernate mode to conserve the amount of electrical power allocated to each device attached to the computer.

**AGP** — accelerated graphics port — A dedicated graphics port that allows system memory to be used for video-related tasks. AGP delivers a smooth, true-color video image because of the faster interface between the video circuitry and the computer memory.

**antivirus software** — A program designed to identify, quarantine, and/or delete viruses from your computer.

**APR** — advanced port replicator — A docking device that allows you to conveniently use a monitor, keyboard, mouse, and other devices with your portable computer.

**ASF** — alert standards format — A standard to define a mechanism for reporting hardware and software alerts to a management console. ASF is designed to be platform- and operating system-independent.

---

#### B

**backup** — A copy of a program or data file on a floppy, CD, or hard drive. As a precaution, back up the data files from your hard drive regularly.

**battery** — An internal power source used to operate portable computers when not connected to an AC adapter and an electrical outlet.

**battery life span** — The length of time (years) during which a portable computer battery is able to be depleted and recharged.

**battery operating time** — The length of time (minutes or hours) that a portable computer battery holds a charge while powering the computer.

**BIOS** — basic input/output system — A program (or utility) that serves as an interface between the computer hardware and the operating system. Unless you understand what effect the settings have on the computer, do not change the settings for this program. Also referred to as *system setup*.

**bit** — The smallest unit of data interpreted by your computer.

**Bluetooth® wireless technology** — A wireless technology standard for short-range (9 m [29 feet]) networking devices that allows for enabled devices to automatically recognize each other.

**boot sequence** — Specifies the order of the devices from which the computer attempts to boot.

**bootable CD** — A CD that you can use to start your computer. In case your hard drive is damaged or your computer has a virus, ensure that you always have a bootable CD or floppy available. Your *Drivers and Utilities* or *ResourceCD* is a bootable CD.

**bootable disk** — A disk that you can use to start your computer. In case your hard drive is damaged or your computer has a virus, ensure that you always have a bootable CD or floppy available.

**bps** — bits per second — The standard unit for measuring data transmission speed.

**BTU** — British thermal unit — A measurement of heat output.

**bus** — A communication pathway between the components in your computer.

**bus speed** — The speed, given in MHz, that indicates how fast a bus can transfer information.

**byte** — The basic data unit used by your computer. A byte is usually equal to 8 bits.

---

#### C

**C** — Celsius — A temperature measurement system where 0° is the freezing point and 100° is the boiling point of water.

**cache** — A special high-speed storage mechanism which can be either a reserved section of main memory or an independent high-speed storage device. The cache enhances the efficiency of many processor operations.

**L1 cache** — Primary cache stored inside the processor.

**L2 cache** — Secondary cache which can either be external to the processor or incorporated into the processor architecture.

**carnet** — An international customs document that facilitates temporary imports into foreign countries. Also known as a *merchandise passport*.

**CD** — compact disc — An optical form of storage media, typically used for audio and software programs.

**CD drive** — A drive that uses optical technology to read data from CDs.

**CD player** — The software used to play music CDs. The CD player displays a window with buttons that you use to play a CD.

**CD-R** — CD recordable — A recordable version of a CD. Data can be recorded only once onto a CD-R. Once recorded, the data cannot be erased or written over.

**CD-RW** — CD rewritable — A rewritable version of a CD. Data can be written to a CD-RW disc, and then erased and written over (rewritten).

**CD-RW drive** — A drive that can read CDs and write to CD-RW (rewritable CDs) and CD-R (recordable CDs) discs. You can write to CD-RW discs multiple times, but you can write to CD-R discs only once.

**CD-RW/DVD drive** — A drive, sometimes referred to as a combo drive, that can read CDs and DVDs and write to CD-RW (rewritable CDs) and CD-R (recordable CDs) discs. You can write to CD-RW discs multiple times, but you can write to CD-R discs only once.

**clock speed** — The speed, given in MHz, that indicates how fast computer components that are connected to the system bus operate.

**COA** — Certificate of Authenticity — The Windows alpha-numeric code located on a sticker on your computer. Also referred to as the *Product Key* or *Product ID*.

**Control Panel** — A Windows utility that allows you to modify operating system and hardware settings, such as display settings.

**controller** — A chip that controls the transfer of data between the processor and memory or between the processor and devices.

**CRIMM** — continuity rambus in-line memory module — A special module that has no memory chips and is used to fill unused RIMM slots.

**cursor** — The marker on a display or screen that shows where the next keyboard, touch pad, or mouse action will occur. It often is a blinking solid line, an underline character, or a small arrow.

---

## D

**DDR SDRAM** — double-data-rate SDRAM — A type of SDRAM that doubles the data burst cycle, improving system performance.

**DDR2 SDRAM** — double-data-rate 2 SDRAM — A type of DDR SDRAM that uses a 4-bit prefetch and other architectural changes to boost memory speed to over 400 MHz.

**device** — Hardware such as a disk drive, printer, or keyboard that is installed in or connected to your computer.

**device driver** — See *driver*.

**DIN connector** — A round, six-pin connector that conforms to DIN (Deutsche Industrie-Norm) standards; it is typically used to connect PS/2 keyboard or mouse cable connectors.

**disk striping** — A technique for spreading data over multiple disk drives. Disk striping can speed up operations that retrieve data from disk storage. Computers that use disk striping generally allow the user to select the data unit size or stripe width.

**DMA** — direct memory access — A channel that allows certain types of data transfer between RAM and a device to bypass the processor.

**docking device** — See *APR*.

**DMTF** — Distributed Management Task Force — A consortium of hardware and software companies who develop management standards for distributed desktop, network, enterprise, and Internet environments.

**domain** — A group of computers, programs, and devices on a network that are administered as a unit with common rules and procedures for use by a specific group of users. A user logs on to the domain to gain access to the resources.

**DRAM** — dynamic random-access memory — Memory that stores information in integrated circuits containing capacitors.

**driver** — Software that allows the operating system to control a device such as a printer. Many devices do not work properly if the correct driver is not installed in the computer.

**DSL** — Digital Subscriber Line — A technology that provides a constant, high-speed Internet connection through an analog telephone line.

**dual display mode** — A display setting that allows you to use a second monitor as an extension of your display. Also referred to as *extended display mode*.

**DVD** — digital versatile disc — A disc usually used to store movies. DVDs are double-sided, whereas CDs are single-sided. DVD drives read most CD media as well.

**DVD drive** — A drive that uses optical technology to read data from DVDs and CDs.

**DVD player** — The software used to watch DVD movies. The DVD player displays a window with buttons that you use to watch a movie.

**DVD+RW** — DVD rewritable — A rewritable version of a DVD. Data can be written to a DVD+RW disc, and then erased and written over (rewritten). (DVD+RW technology is different from DVD-RW technology.)

**DVD+RW drive** — A drive that can read DVDs and most CD media and write to DVD+RW (rewritable DVDs) discs.

**DVI** — digital video interface — A standard for digital transmission between a computer and a digital video display; the DVI adapter works through the computer's integrated graphics.

---

## E

**ECC** — error checking and correction — A type of memory that includes special circuitry for testing the accuracy of data as it passes in and out of memory.

**ECP** — extended capabilities port — A parallel connector design that provides improved bidirectional data transmission. Similar to EPP, ECP uses direct memory access to transfer data and often improves performance.

**EIDE** — enhanced integrated device electronics — An improved version of the IDE interface for hard drives and CD drives.

**EMI** — electromagnetic interference — Electrical interference caused by electromagnetic radiation.

**ENERGY STAR®** — Environmental Protection Agency requirements that decrease the overall consumption of electricity.

**EPP** — enhanced parallel port — A parallel connector design that provides bidirectional data transmission.

**ESD** — electrostatic discharge — A rapid discharge of static electricity. ESD can damage integrated circuits found in computer and communications equipment.

**expansion card** — A circuit board that installs in an expansion slot on the system board in some computers, expanding the capabilities of the computer. Examples include video, modem, and sound cards.

**expansion slot** — A connector on the system board (in some computers) where you insert an expansion card, connecting it to the system bus.

**Express Service Code** — A numeric code located on a sticker on your Dell™ computer. Use the Express Service Code when contacting Dell for assistance. Express Service Code service may not be available in some countries.

**extended display mode** — A display setting that allows you to use a second monitor as an extension of your display. Also referred to as *dual display mode*.

**extended PC Card** — A PC Card that extends beyond the edge of the PC Card slot when installed.

---

## F

**Fahrenheit** — A temperature measurement system where 32° is the freezing point and 212° is the boiling point of water.

**FCC** — Federal Communications Commission — A U.S. agency responsible for enforcing communications-related regulations that state how much radiation computers and other electronic equipment can emit.

**floppy drive** — A disk drive that can read and write to floppies.

**folder** — A term used to describe space on a disk or drive where files are organized and grouped. Files in a folder can be viewed and ordered in various ways, such as alphabetically, by date, and by size.

**format** — The process that prepares a drive or disk for file storage. When a drive or disk is formatted, the existing information on it is lost.

**FSB** — front side bus — The data path and physical interface between the processor and RAM.

**FTP** — file transfer protocol — A standard Internet protocol used to exchange files between computers connected to the Internet.

---

## G

**G** — gravity — A measurement of weight and force.

**GB** — gigabyte — A measurement of data storage that equals 1024 MB (1,073,741,824 bytes). When used to refer to hard drive storage, the term is often rounded to 1,000,000,000 bytes.

**GHz** — gigahertz — A measurement of frequency that equals one thousand million Hz, or one thousand MHz. The speeds for computer processors, buses, and interfaces are often measured in GHz.

**graphics mode** — A video mode that can be defined as x horizontal pixels by y vertical pixels by z colors. Graphics modes can display an unlimited variety of shapes and fonts.

**GUI** — graphical user interface — Software that interacts with the user by means of menus, windows, and icons. Most programs that operate on the Windows operating systems are GUIs.

---

## H

**hard drive** — A drive that reads and writes data on a hard disk. The terms hard drive and hard disk are often used interchangeably.

**heat sink** — A metal plate on some processors that helps dissipate heat.

**help file** — A file that contains descriptive or instructional information about a product. Some help files are associated with a particular program, such as *Help* in Microsoft Word. Other help files function as stand-alone reference sources. Help files typically have a filename extension of **.hlp** or **.chm**.

**hibernate mode** — A power management mode that saves everything in memory to a reserved space on the hard drive and then turns off the computer. When you restart the computer, the memory information that was saved to the hard drive is automatically restored.

**HTML** — hypertext markup language — A set of codes inserted into an Internet web page intended for display on an Internet browser.

**HTTP** — hypertext transfer protocol — A protocol for exchanging files between computers connected to the Internet.

**Hz** — hertz — A unit of frequency measurement that equals 1 cycle per second. Computers and electronic devices are often measured in kilohertz (kHz), megahertz (MHz), gigahertz (GHz), or terahertz (THz).

---

## I

**IC** — Industry Canada — The Canadian regulatory body responsible for regulating emissions from electronic equipment, much as the FCC does in the United States.

**IC** — integrated circuit — A semiconductor wafer, or chip, on which thousands or millions of tiny electronic components are fabricated for use in computer, audio, and video equipment.

**IDE** — integrated device electronics — An interface for mass storage devices in which the controller is integrated into the hard drive or CD drive.

**IEEE 1394** — Institute of Electrical and Electronics Engineers, Inc. — A high-performance serial bus used to connect IEEE 1394-compatible devices, such as digital cameras and DVD players, to the computer.

**infrared sensor** — A port that allows you to transfer data between the computer and infrared-compatible devices without using a cable connection.

**integrated** — Usually refers to components that are physically located on the computer's system board. Also referred to as *built-in*.

**I/O** — input/output — An operation or device that enters and extracts data from your computer. Keyboards and printers are I/O devices.

**I/O address** — An address in RAM that is associated with a specific device (such as a serial connector, parallel connector, or expansion slot) and allows the processor to communicate with that device.

**IrDA** — Infrared Data Association — The organization that creates international standards for infrared communications.

**IRQ** — interrupt request — An electronic pathway assigned to a specific device so that the device can communicate with the processor. Each device connection must be assigned an IRQ. Although two devices can share the same IRQ assignment, you cannot operate both devices simultaneously.

**ISP** — Internet service provider — A company that allows you to access its host server to connect directly to the Internet, send and receive e-mail, and access websites. The ISP typically provides you with a software package, user name, and access phone numbers for a fee.

---

## K

**Kb** — kilobit — A unit of data that equals 1024 bits. A measurement of the capacity of memory integrated circuits.

**KB** — kilobyte — A unit of data that equals 1024 bytes but is often referred to as 1000 bytes.

**key combination** — A command requiring you to press multiple keys at the same time.

**kHz** — kilohertz — A measurement of frequency that equals 1000 Hz.

---

## L

**LAN** — local area network — A computer network covering a small area. A LAN usually is confined to a building or a few nearby buildings. A LAN can be connected to another LAN over any distance through telephone lines and radio waves to form a wide area network (WAN).

**LCD** — liquid crystal display — The technology used by portable computer and flat-panel displays.

**LED** — light-emitting diode — An electronic component that emits light to indicate the status of the computer.

**local bus** — A data bus that provides a fast throughput for devices to the processor.

**LPT** — line print terminal — The designation for a parallel connection to a printer or other parallel device.

---

## M

**Mb** — megabit — A measurement of memory chip capacity that equals 1024 Kb.

**Mbps** — megabits per second — One million bits per second. This measurement is typically used for transmission speeds for networks and modems.

**MB** — megabyte — A measurement of data storage that equals 1,048,576 bytes. 1 MB equals 1024 KB. When used to refer to hard drive storage, the term is often rounded to 1,000,000 bytes.

**MB/sec** — megabytes per second — One million bytes per second. This measurement is typically used for data transfer ratings.

**memory** — A temporary data storage area inside your computer. Because the data in memory is not permanent, it is recommended that you frequently save your files while you are working on them, and always save your files before you shut down the computer. Your computer can contain several different forms of memory, such as RAM, ROM, and video memory. Frequently, the word memory is used as a synonym for RAM.

**memory address** — A specific location where data is temporarily stored in RAM.



**memory mapping** — The process by which the computer assigns memory addresses to physical locations at start-up. Devices and software can then identify information that the processor can access.

**memory module** — A small circuit board containing memory chips, which connects to the system board.

**MHz** — megahertz — A measure of frequency that equals 1 million cycles per second. The speeds for computer processors, buses, and interfaces are often measured in MHz.

**modem** — A device that allows your computer to communicate with other computers over analog telephone lines. Three types of modems include: external, PC Card, and internal. You typically use your modem to connect to the Internet and exchange e-mail.

**module bay** — A bay that supports devices such as optical drives, a second battery, or a Dell TravelLite™ module.

**monitor** — The high-resolution TV-like device that displays computer output.

**mouse** — A pointing device that controls the movement of the cursor on your screen. Typically you roll the mouse over a hard, flat surface to move the pointer or cursor on your screen.

**ms** — millisecond — A measure of time that equals one thousandth of a second. Access times of storage devices are often measured in ms.

---

## N

**network adapter** — A chip that provides network capabilities. A computer may include a network adapter on its system board, or it may contain a PC Card with an adapter on it. A network adapter is also referred to as a *NIC* (network interface controller).

**NIC** — See *network adapter*.

**notification area** — The section of the Windows taskbar that contains icons for providing quick access to programs and computer functions, such as the clock, volume control, and print status. Also referred to as *system tray*.

**ns** — nanosecond — A measure of time that equals one billionth of a second.

**NVRAM** — nonvolatile random access memory — A type of memory that stores data when the computer is turned off or loses its external power source. NVRAM is used for maintaining computer configuration information such as date, time, and other system setup options that you can set.

---

## O

**optical drive** — A drive that uses optical technology to read or write data from CDs, DVDs, or DVD+RWs. Example of optical drives include CD drives, DVD drives, CD-RW drives, and CD-RW/DVD combo drives.

---

## P

**parallel connector** — An I/O port often used to connect a parallel printer to your computer. Also referred to as an *LPT port*.

**partition** — A physical storage area on a hard drive that is assigned to one or more logical storage areas known as logical drives. Each partition can contain multiple logical drives.

**PC Card** — A removable I/O card adhering to the PCMCIA standard. Modems and network adapters are common types of PC Cards.

**PCI** — peripheral component interconnect — PCI is a local bus that supports 32-and 64-bit data paths, providing a high-speed data path between the processor and devices such as video, drives, and networks.

and devices such as video, drives, and networks.

**PCI Express** — A modification to the PCI interface that boosts the data transfer rate between the processor and the devices attached to it. PCI Express can transfer data at speeds from 250 MB/sec to 4 GB/sec. If the PCI Express chip set and the device are capable of different speeds, they will operate at the slower speed.

**PCMCIA** — Personal Computer Memory Card International Association — The organization that establishes standards for PC Cards.

**PIN** — personal identification number — A sequence of numerals and/or letters used to restrict unauthorized access to computer networks and other secure systems.

**PIO** — programmed input/output — A method of transferring data between two devices through the processor as part of the data path.

**pixel** — A single point on a display screen. Pixels are arranged in rows and columns to create an image. A video resolution, such as 800 x 600, is expressed as the number of pixels across by the number of pixels up and down.

**Plug-and-Play** — The ability of the computer to automatically configure devices. Plug and Play provides automatic installation, configuration, and compatibility with existing hardware if the BIOS, operating system, and all devices are Plug and Play compliant.

**POST** — power-on self-test — Diagnostics programs, loaded automatically by the BIOS, that perform basic tests on the major computer components, such as memory, hard drives, and video. If no problems are detected during POST, the computer continues the start-up.

**processor** — A computer chip that interprets and executes program instructions. Sometimes the processor is referred to as the CPU (central processing unit).

**program** — Any software that processes data for you, including spreadsheet, word processor, database, and game packages. Programs require an operating system to run.

**PS/2** — personal system/2 — A type of connector for attaching a PS/2-compatible keyboard, mouse, or keypad.

**PXE** — pre-boot execution environment — A WfM (Wired for Management) standard that allows networked computers that do not have an operating system to be configured and started remotely.

---

## R

**RAID** — redundant array of independent disks — A method of providing data redundancy. Some common implementations of RAID include RAID 0, RAID 1, RAID 5, RAID 10, and RAID 50.

**RAM** — random-access memory — The primary temporary storage area for program instructions and data. Any information stored in RAM is lost when you shut down your computer.

**readme file** — A text file included with a software package or hardware product. Typically, readme files provide installation information and describe new product enhancements or corrections that have not yet been documented.

**read-only** — Data and/or files you can view but cannot edit or delete. A file can have read-only status if:

- o It resides on a physically write-protected floppy, CD, or DVD.
- o It is located on a network in a directory and the system administrator has assigned rights only to specific individuals.

**refresh rate** — The frequency, measured in Hz, at which your screen's horizontal lines are recharged (sometimes also referred to as its *vertical frequency*). The higher the refresh rate, the less video flicker can be seen by the human eye.

**resolution** — The sharpness and clarity of an image produced by a printer or displayed on a monitor. The higher the resolution, the sharper the image.

**RFI** — radio frequency interference — Interference that is generated at typical radio frequencies, in the range of 10 kHz to 100,000 MHz. Radio frequencies are at the lower end of the electromagnetic frequency spectrum and are more likely to have interference than the higher frequency radiations, such as infrared and light.

**ROM** — read-only memory — Memory that stores data and programs that cannot be deleted or written to by the computer. ROM, unlike RAM, retains its contents after you shut down your computer. Some programs essential to the operation of your computer reside in ROM.

**RPM** — revolutions per minute — The number of rotations that occur per minute. Hard drive speed is often measured in rpm.

**RTC** — real time clock — Battery-powered clock on the system board that keeps the date and time after you shut down the computer.

**RTCST** — real-time clock reset — A jumper on the system board of some computers that can often be used for troubleshooting problems.

---

## S

**ScanDisk** — A Microsoft utility that checks files, folders, and the hard disk's surface for errors. ScanDisk often runs when you restart the computer after it has stopped responding.

**SDRAM** — synchronous dynamic random-access memory — A type of DRAM that is synchronized with the optimal clock speed of the processor.

**serial connector** — An I/O port often used to connect devices such as a handheld digital device or digital camera to your computer.

**Service Tag** — A bar code label on your computer that identifies your computer when you access Dell Support at [support.dell.com](http://support.dell.com) or when you call Dell for customer service or technical support.

**setup program** — A program that is used to install and configure hardware and software. The **setup.exe** or **install.exe** program comes with most Windows software packages. *Setup program* differs from *system setup*.

**shortcut** — An icon that provides quick access to frequently used programs, files, folders, and drives. When you place a shortcut on your Windows desktop and double-click the icon, you can open its corresponding folder or file without having to find it first. Shortcut icons do not change the location of files. If you delete a shortcut, the original file is not affected. Also, you can rename a shortcut icon.

**shutdown** — The process of closing windows and exiting programs, exiting the operating system, and turning off your computer. You can lose data if you turn off your computer before completing a shutdown.

**smart card** — A card that is embedded with a processor and a memory chip. Smart cards can be used to authenticate a user on computers equipped for smart cards.

**software** — Anything that can be stored electronically, such as computer files or programs.

**S/PDIF** — Sony/Philips Digital Interface — An audio transfer file format that allows the transfer of audio from one file to another without converting it to and from an analog format, which could degrade the quality of the file.

**standby mode** — A power management mode that shuts down all unnecessary computer operations to save energy.

**Strikezone™** — Reinforced area of the platform base that protects the hard drive by acting as a dampening device when a computer experiences resonating shock or is dropped (whether the computer is on or off).

**surge protectors** — Prevent voltage spikes, such as those that may occur during an electrical storm, from entering the computer through the electrical outlet. Surge protectors do not protect against lightning strikes or against brownouts, which occur when the voltage drops more than 20 percent below the normal AC-line voltage level.

Network connections cannot be protected by surge protectors. Always disconnect the network cable from the network connector during electrical storms.

**SVGA** — super-video graphics array — A video standard for video adapters and controllers. Typical SVGA resolutions are 800 x 600 and 1024 x 768.

The number of colors and resolution that a program displays depends on the capabilities of the monitor, the video controller and its drivers, and the amount of video memory installed in the computer.

**S-video TV-out** — A connector used to attach a TV or digital audio device to the computer.

**SXGA** — super-extended graphics array — A video standard for video adapters and controllers that supports resolutions up to 1280 x 1024.

**SXGA+** — super-extended graphics array plus — A video standard for video adapters and controllers that supports resolutions up to 1400 x 1050.

**system board** — The main circuit board in your computer. Also known as the *motherboard*.

**system setup** — A utility that serves as an interface between the computer hardware and the operating system. System setup allows you to configure user-selectable options in the BIOS, such as date and time or system password. Unless you understand what effect the settings have on the computer, do not change the settings for this program.

**system tray** — See *notification area*.

---

## T

**TAPI** — telephony application programming interface — Enables Windows programs to operate with a wide variety of telephony devices, including voice, data, fax, and video.

**text editor** — A program used to create and edit files that contain only text; for example, Windows Notepad uses a text editor. Text editors do not usually provide word wrap or formatting functionality (the option to underline, change fonts, and so on).

**travel module** — A plastic device designed to fit inside the module bay of a portable computer to reduce the weight of the computer.

---

## U

**UMA** — unified memory allocation— System memory dynamically allocated to video memory.

**UPS** — uninterruptible power supply — A backup power source used when the electrical power fails or drops to an unacceptable voltage level. A UPS keeps a computer running for a limited amount of time when there is no electrical power. UPS systems typically provide surge suppression and may also provide voltage regulation. Small UPS systems provide battery power for a few minutes to enable you to shut down your computer.

**USB** — universal serial bus — A hardware interface for a low-speed device such as a USB-compatible keyboard, mouse, joystick, scanner, set of speakers, printer, broadband devices (DSL and cable modems), imaging devices, or storage devices. Devices are plugged directly in to a 4-pin socket on your computer or in to a multi-port hub that plugs in to your computer. USB devices can be connected and disconnected while the computer is turned on, and they can also be daisy-chained together.

**UTP** — unshielded twisted pair — Describes a type of cable used in most telephone networks and some computer networks. Pairs of unshielded wires are twisted to protect against electromagnetic interference, rather than relying on a metal sheath around each pair of wires to protect against interference.

**UXGA** — ultra extended graphics array — A video standard for video adapters and controllers that supports resolutions up to 1600 x 1200.

---

## V

**video controller** — The circuitry on a video adapter or on the system board (in computers with an integrated video controller) that provides the video capabilities—in combination with the monitor—for your computer.

**video memory** — Memory that consists of memory chips dedicated to video functions. Video memory is usually faster than system memory. The amount of video memory installed primarily influences the number of colors that a program can display.

**video mode** — A mode that describes how text and graphics are displayed on a monitor. Graphics-based software, such as Windows operating systems, displays in video modes that can be defined as *x* horizontal pixels by *y* vertical pixels by *z* colors. Character-based software, such as text editors, displays in video modes that can be defined as *x* columns by *y* rows of characters.

**video resolution** — See *resolution*.

**virus** — A program that is designed to inconvenience you or to destroy data stored on your computer. A virus program moves from one computer to another through an infected disk, software downloaded from the Internet, or e-mail attachments. When an infected program starts, its embedded virus also starts.

A common type of virus is a boot virus, which is stored in the boot sectors of a floppy. If the floppy is left in the drive when the computer is shut down and then turned on, the computer is infected when it reads the boot sectors of the floppy expecting to find the operating system. If the computer is infected, the boot virus may replicate itself onto all the floppies that are read or written in that computer until the virus is eradicated.

**V** — volt — The measurement of electric potential or electromotive force. One V appears across a resistance of 1 ohm when a current of 1 ampere flows through that resistance.

---

## W

**W** — watt — The measurement of electrical power. One W is 1 ampere of current flowing at 1 volt.

**Whr** — watt-hour — A unit of measure commonly used to indicate the approximate capacity of a battery. For example, a 66-Whr battery can supply 66 W of power for 1 hour or 33 W for 2 hours.

**wallpaper** — The background pattern or picture on the Windows desktop. Change your wallpaper through the Windows Control Panel. You can also scan in your favorite picture and make it wallpaper.

**write-protected** — Files or media that cannot be changed. Use write-protection when you want to protect data from being changed or destroyed. To write-protect a 3.5-inch floppy, slide its write-protect tab to the open position.

---

## X

**XGA** — extended graphics array — A video standard for video adapters and controllers that supports resolutions up to 1024 x 768.

---

## Z

**ZIF** — zero insertion force — A type of socket or connector that allows a computer chip to be installed or removed with no stress applied to either the chip or its socket.

**Zip** — A popular data compression format. Files that have been compressed with the Zip format are called Zip files and usually have a filename extension of **.zip**. A special kind of zipped file is a self-extracting file, which has a filename extension of **.exe**. You can unzip a self-extracting file by double-clicking it.

**Zip drive** — A high-capacity floppy drive developed by Iomega Corporation that uses 3.5-inch removable disks called Zip disks. Zip disks are slightly larger than regular floppies, about twice as thick, and hold up to 100 MB of data.

---

[Back to Contents Page](#)

## Using the Keyboard and Touch Pad

### Dell™ Latitude™ D610 User's Guide

- [Numeric Keypad](#)
- [Key Combinations](#)
- [Touch Pad](#)
- [Changing the Track Stick Cap](#)

---

## Numeric Keypad

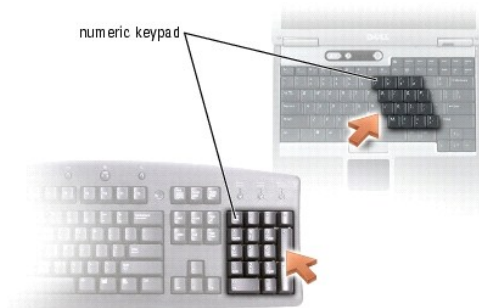

The numeric keypad functions like the numeric keypad on an external keyboard. Each key on the keypad has multiple functions. The keypad numbers and symbols are marked in blue on the right of the keypad keys. To type a number or symbol, hold down <Fn> and press the desired key.

- 1 To enable the keypad, press <Num Lk>. The  light indicates that the keypad is active.
- 1 To disable the keypad, press <Num Lk> again.

---

## Key Combinations

### System Functions

<Ctrl><Shift><Esc>	Opens the <b>Task Manager</b> window
<Fn><Num Lock>	Enables and disables the scroll lock

### Battery

<Fn><F3>	Displays the Dell™ QuickSet Battery Meter
----------	---

### CD or DVD Tray

<Fn><F10>	Ejects the tray out of the drive (if Dell QuickSet is installed).
-----------	---

### Display Functions

<Fn><F8>	Switches the video image to the next display option. The options include the integrated display, an external monitor, and both displays simultaneously.
<Fn> and up-arrow key	Increases brightness on the integrated display only (not on an external monitor).
<Fn> and down-arrow key	Decreases brightness on the integrated display only (not on an external monitor).

## Radios (Including Wireless Networking and Bluetooth® Wireless Technology)

<Fn><F2>	Enables and disables radios, including wireless networking and Bluetooth wireless technology
----------	--

## Power Management

<Fn><Esc>	Activates a power management mode. You can reprogram this keyboard shortcut to activate a different power management mode using the Advanced tab in the <b>Power Options Properties</b> window.
<Fn><F1>	Places your computer in hibernation.

## Speaker Functions

<Fn><Page Up>	Increases the volume of the integrated speakers and external speakers, if attached
<Fn><Page Dn>	Decreases the volume of the integrated speakers and external speakers, if attached
<Fn><End>	Enables and disables the integrated speakers and external speakers, if attached

## Microsoft® Windows® Logo Key Functions

Windows logo key and <m>	Minimizes all open windows
Windows logo key and <Shift><m>	Maximizes all windows
Windows logo key and <e>	Runs Windows Explorer
Windows logo key and <r>	Opens the <b>Run</b> dialog box
Windows logo key and <f>	Opens the <b>Search Results</b> dialog box
Windows logo key and <Ctrl><f>	Opens the <b>Search Results-Computer</b> dialog box (if the computer is connected to a network)
Windows logo key and <Pause>	Opens the <b>System Properties</b> dialog box

To adjust keyboard operation, such as the character repeat rate, open the [Control Panel](#), click **Printers and Other Hardware**, and click **Keyboard**.

## Touch Pad

The touch pad detects the pressure and movement of your finger to allow you to move the cursor on the display. Use the touch pad and touch pad buttons as you would use a mouse.



1	track stick	3	touch pad
2	track stick buttons	4	touch pad buttons

- 1 To move the cursor, lightly slide your finger over the touch pad.
- 1 To select an object, lightly tap once on the surface of the touch pad or use your thumb to press the left touch-pad button.

- 1 To select and move (or drag) an object, position the cursor on the object and tap twice on the touch pad. On the second tap, leave your finger on the touch pad and move the selected object by sliding your finger over the surface.
- 1 To double-click an object, position the cursor on the object and tap twice on the touch pad or use your thumb to press the left touch-pad button twice.

You can also use the track stick to move the cursor. Press the track stick left, right, up, or down to change the direction of the cursor on the display. Use the track stick and track stick buttons as you would use a mouse.

## Customizing the Touch Pad and Track Stick

You can use the **Mouse Properties** window to disable the touch pad and track stick or adjust their settings.

1. Open the [Control Panel](#), click **Printers and Other Hardware**, and then click **Mouse**.
2. In the **Mouse Properties** window:
  - 1 Click the **Device Select** tab to disable the touch pad and track stick.
  - 1 Click the **Pointer** tab to adjust touch pad and track stick settings.
3. Click **OK** to save the settings and close the window.

---

## Changing the Track Stick Cap

You can replace your track stick cap if it wears down from prolonged use or if you prefer a different color. You can purchase additional caps by visiting the Dell website at [www.dell.com](http://www.dell.com).

 **NOTE:** You may not be able to purchase additional caps from Dell in certain countries.



1. Pull the cap off the track stick.
2. Align the new cap over the square track-stick post and gently press the cap down onto the post.

 **NOTE:** The track stick can damage the display if it is not properly seated on the post.

3. Test the track stick to ensure that the cap is seated properly.

---

[Back to Contents Page](#)

[Back to Contents Page](#)

## Passwords

### Dell™ Latitude™ D610 User's Guide

- [About Passwords](#)
- [Using a Primary Password](#)
- [Using an Administrator Password](#)
- [Using a Hard Drive Password](#)
- [About Asset Tags](#)
- [Enabling Trusted Platform Module \(TPM\)](#)

---

## About Passwords

 **NOTE:** Passwords are disabled when you receive your computer.

A primary password, an administrator password, and a hard drive password all prevent unauthorized access to your computer in different ways. The following table identifies types and features of passwords available on your computer.

Type of Password	Features
Primary	<ul style="list-style-type: none"><li>1 Protects the computer from unauthorized access</li></ul>
Administrator	<ul style="list-style-type: none"><li>1 Gives system administrators or service technicians access to computers for repair or reconfiguration</li><li>1 Allows you to restrict access to system setup in the same way a primary password restricts access to the computer</li><li>1 Can be used instead of the primary password</li></ul>
Hard drive	<ul style="list-style-type: none"><li>1 Helps protect the data on your hard drive or external hard drive (if one is being used) from unauthorized access</li></ul>

 **NOTE:** Only hard drives purchased from Dell for use with the Dell™ Latitude™ D-Family computers support hard drive passwords.

 **NOTICE:** Passwords provide a high level of security for data in your computer or hard drive. However, they are not foolproof. If you require more security, obtain and use additional forms of protection, such as smart cards, data encryption programs, or PC Cards with encryption features.

If you forget any of your passwords, contact your system administrator or [contact Dell](#). For your protection, Dell technical support staff will ask you for proof of your identity to ensure that only an authorized person can use the computer.

---

## Using a Primary Password

The primary password allows you to protect the computer from unauthorized access.

When you first start your computer, you must assign a primary password at the prompt.

After assigning a primary password, you must enter it each time you turn on your computer. The following message appears each time you turn on the computer:

Please type in the primary or administrator password and press <Enter>.

To continue, enter your password (with no more than eight characters).

If you do not enter a password within 2 minutes, the computer returns to its previous operating state.

 **NOTICE:** If you disable the administrator password, the primary password is also disabled.

If you have assigned an administrator password, you can use it instead of the primary password. The computer does not specifically prompt you for the administrator password.

---

## Using an Administrator Password

The administrator password is designed to give system administrators or service technicians access to computers for repair or reconfiguration. The administrators or technicians can assign identical administrator passwords to groups of computers, allowing you to assign the primary password.



To set or change administrator passwords, access **User Accounts** from the Control Panel.

When you set an administrator password, the **Configure Setup** option becomes available in system setup. The **Configure Setup** option allows you to restrict access to system setup in the same way that a primary password restricts access to the computer.

The administrator password can be used instead of the primary password. Whenever you are prompted to enter the primary password, you can enter the administrator password.

 **NOTICE:** If you disable the administrator password, the primary password is also disabled.

 **NOTE:** The administrator password provides access to the computer, but it does not provide access to the hard drive when a hard drive password is assigned.

If you forget the primary password and do not have an administrator password assigned, or if you have both a primary and an administrator password assigned but forget them both, contact your system administrator or [contact Dell](#).

---

## Using a Hard Drive Password

The hard drive password helps protect the data on your hard drive from unauthorized access. You can also assign a password for an external hard drive (if one is being used) that can be the same as or different from the password for the primary hard drive.

To assign or change a hard drive password, enter [system setup](#).

After assigning a hard drive password, you must enter it each time you turn on the computer and each time you restore the computer to normal operation from standby mode.

If the hard drive password is enabled, the following message appears each time you turn on the computer:

Please type in the hard-disk drive password and press <Enter>.

To continue, enter your password (with no more than eight characters). Press <Esc> to return the computer to its previous operating state.

If you do not enter a password within 2 minutes, the computer returns to its previous operating state.

If you enter the wrong password, the following message appears:

Invalid password  
[Press Enter to retry]

If you do not enter the correct password in three attempts, the computer tries to start from another bootable device if the **Boot First Device** option in system setup is set to allow start-up from another device. If the **Boot First Device** option is not set to allow the computer to start from another device, the computer returns to the operating state it was in when you turned it on.

If the hard drive password, the external hard-drive password, and the primary password are the same, the computer prompts you only for the primary password. If the hard drive password is different from the primary password, the computer prompts you for both. Two different passwords provide greater security.

 **NOTE:** The administrator password provides access to the computer, but it does not provide access to a hard drive that is protected by a hard drive password.

---

## About Asset Tags

 **NOTE:** Some of these features may not be available for your computer or in certain countries.

## Using the Dell™ Portables Asset Tag Utility

The Asset Tag utility allows you to enter an asset tag that you or your company assigns to the computer. After you enter an asset tag, the tag appears in the system setup screens.

You can also use the Asset Tag utility to enter an owner tag that appears in the system log-on screen and with the primary password prompt.

To create a bootable floppy disk, download the **Dell Portables Asset Tag** utility from the [support.dell.com](#) website, and then use the floppy disk to assign an asset tag.

The Dell Portables Asset Tag utility may not be available as a download in certain countries.

## Assigning an Asset Tag

Use a bootable floppy disk to assign an asset tag.

1. Boot the computer, using the bootable floppy disk:
  - a. Restart the computer.
  - b. Press <F12> immediately after the DELL™ logo appears.

If the operating system logo appears, wait until you see the Microsoft® Windows® desktop, and then shut down the computer and try again.

- c. Press the arrow keys to select **Diskette Drive** and press <Enter>.
2. Type `asset` and a space followed by the new asset tag, and press <Enter>.

For example, type the following command line and press <Enter>:

```
asset 1234$ABCD&
```

 **NOTE:** An asset tag can have up to 10 characters; any combination of characters excluding spaces is valid.

3. When the computer prompts you to verify the asset tag, type `y`.  
The computer displays the new or modified asset tag and the Service Tag.
4. Restart your computer to exit the Asset Tag utility.

## Viewing Existing Asset and Service Tags

1. Boot the computer using a bootable floppy disk.
2. Type `asset` and press <Enter>.

## Deleting an Asset Tag

1. Boot the computer using the bootable floppy disk you created in "[Using the Dell™ Portables Asset Tag Utility](#)."
2. Type `asset /d` and press <Enter>.
3. When the computer prompts you to delete the asset tag, type `y`.

## Assigning an Owner Tag

An owner tag can have up to 48 characters; any combination of letters, numbers, and spaces is valid.

1. Boot the computer using the bootable floppy disk you created in "[Using the Dell™ Portables Asset Tag Utility](#)."
2. Type `asset /o` and a space followed by the new owner tag, and press <Enter>.

For example, type the following command line and press <Enter>:

```
asset /o ABC Company
```

3. When the computer prompts you to verify the owner tag, type `y`.  
The computer displays the new owner tag.

## Deleting an Owner Tag

 **NOTE:** For security, you cannot set, change, or delete the owner tag if the primary or administrator passwords are set.

1. Boot the computer using the bootable floppy disk you created in "[Using the Dell™ Portables Asset Tag Utility](#)."
2. Type `asset /o /d` and press <Enter>.
3. When the computer prompts you to delete the owner tag, type `y`.

## Asset Tag Options

To use one of the asset tag options (see the following table):

1. Boot the computer using the bootable floppy disk you created in "[Using the Dell™ Portables Asset Tag Utility.](#)"
2. Type `asset` and a space followed by the option, and then press <Enter>.

Asset Tag Option	Description
<code>/d</code>	Deletes the asset tag
<code>/o owner tag</code>	Specifies a new owner tag
<code>/o /d</code>	Deletes the owner tag
<code>/?</code>	Displays the Asset Tag utility help screen

---

## Enabling Trusted Platform Module (TPM)

 **NOTE:** The TPM feature supports encryption only if the operating system supports TPM. For more information, see the software documentation.

TPM is a hardware-based security feature that can be used to create and manage computer-generated encryption keys. When combined with security software, TPM enhances existing network and computer security by enabling features such as file protection capabilities and protected e-mail. The TPM feature is enabled through a TPM system setup option.

 **NOTICE:** If you use TPM, you must follow the backup procedures in the documentation that came with the software to secure your TPM data and encryption keys. In the event of these backups being incomplete, lost, or damaged, Dell will be unable to assist in the recovery of encrypted data.

## Enabling the TPM Feature

1. Turn on your computer.
2. If necessary, install the TPM software.

The TPM software is factory-installed in the `C:\Dell\TPM` directory. You can also download it from [support.dell.com](http://support.dell.com).

3. Run the `setup.exe` file:
  - a. Follow the instructions to install the Broadcom Secure Foundation software.
  - b. If you are using TPM on your computer for the first time, proceed to [step 4](#), otherwise continue with [step 5](#).
4. To enable the TPM software:
  - a. Restart the computer and press <F2> during the Power On Self Test to enter the system setup program.
  - b. Open the **Security** menu in system setup.
  - c. Select the **TPM Security** menu option and press <Enter>.
  - d. Set the TPM security option to **On**.
  - e. Press <Esc> to exit the setup program.
  - f. If prompted, select **Save/Exit**.
5. Activate the TPM setup program:
  - a. Boot your computer to the Microsoft® Windows® operating system.
  - b. Click **Start**→**Programs**→**Broadcom Security Platforms Tools**. Then, click the icon for the **Security Platform Initialization Wizard**.

 **NOTE:** You only need to activate the program once.

- c. Follow the instructions to activate the TPM setup program.

You will be prompted to restart your computer once the process is complete.

6. Physically activate the TPM:
  - a. Restart the computer and press <F2> during the Power On Self Test to enter the system setup program.
  - b. Open the **Security** menu in system setup and select the **TPM Activation** menu option.
  - c. Set the TPM activation state to **Activate**.
  - d. Save the changes and restart your computer.

7. Initialize the TPM owner and user passwords:

- a. Boot your computer to the Microsoft® Windows® operating system.
- b. Click **Start**→ **Programs**→ **Broadcom Security Platforms Tools**. Then, click the icon for the **Security Platform Initialization Wizard**.
- c. Follow the instructions for creating the TPM owner, user passwords, and credentials.

---

[Back to Contents Page](#)

[Back to Contents Page](#)

## Using PC Cards

Dell™ Latitude™ D610 User's Guide

- [PC Card Types](#)
  - [PC Card Blanks](#)
  - [Extended PC Cards](#)
  - [Installing a PC Card](#)
  - [Removing a PC Card or Blank](#)
- 

### PC Card Types

See "[Specifications](#)" for information on supported PC Cards.

 **NOTE:** A PC Card is not a bootable device.

The PC Card slot has one connector that supports a single Type I or Type II card. The PC Card slot supports CardBus technology and extended PC Cards. "Type" of card refers to its thickness, not its functionality.

---

### PC Card Blanks

Your computer shipped with a plastic blank installed in the PC Card slot. Blanks protect unused slots from dust and other particles. Save the blank for use when no PC Card is installed in the slot; blanks from other computers may not fit your computer.

To remove the blank, see "[Removing a PC Card or Blank](#)."

---

### Extended PC Cards

An extended PC Card (for example, a wireless network adapter) is longer than a standard PC Card and extends outside the computer. Follow these precautions when using extended PC Cards:

1. Protect the exposed end of an installed card. Striking the end of the card can damage the system board.
  1. Always remove an extended PC Card before you pack the computer in its carrying case.
- 

### Installing a PC Card

You can install a PC Card in the computer while the computer is running. The computer automatically detects the card.

PC Cards are generally marked with a symbol (such as a triangle or an arrow) to indicate which end to insert into the slot. The cards are keyed to prevent incorrect insertion. If card orientation is not clear, see the documentation that came with the card.

 **CAUTION:** Before you begin any of the procedures in this section, follow the safety instructions in the *Product Information Guide*.

To install a PC Card:

1. Hold the card with its orientation symbol pointing into the slot and the top side of the card facing up. The latch may need to be in the "in" position before you insert the card.
2. Slide the card into the slot until the card is completely seated in its connector.

If you encounter too much resistance, do not force the card. Check the card orientation and try again.



3. Rotate the latch closed after inserting the card.



The computer recognizes most PC Cards and automatically loads the appropriate device driver. If the configuration program tells you to load the manufacturer's drivers, use the floppy or CD that came with the PC Card.

---

## Removing a PC Card or Blank

 **NOTICE:** Use the PC Card configuration utility (click the  icon in the taskbar) to select a card and stop it from functioning before you remove it from the computer. If you do not stop the card in the configuration utility, you could lose data. Do not attempt to eject a card by pulling its cable, if one is attached.

 **CAUTION:** Before you begin any of the procedures in this section, follow the safety instructions in the *Product Information Guide*.

 **NOTE:** This computer uses digital sound, and contains no analog audio lines. PCMCIA cards such as modems that use analog lines to produce sound will not function.

1. Press in on the end of the latch once or twice as applicable.
2. Remove the card or blank.

Save a blank to use when no PC Card is installed in a slot. Blanks protect unused slots from dust and other particles.



1	eject button
2	PC card

---

[Back to Contents Page](#)

[Back to Contents Page](#)

## Dell™ QuickSet

Dell™ Latitude™ D610 User's Guide

 **NOTE:** This feature may not be available on your computer.

Dell™ QuickSet provides you with easy access to configure or view the following types of settings:

- 1 Network connectivity
- 1 Power management
- 1 Display
- 1 System information

Depending on what you want to do in Dell™ QuickSet, you can start it by either *clicking*, *double-clicking*, or *right-clicking* the QuickSet icon,  , in the Microsoft® Windows® taskbar. The taskbar is located in the lower-right corner of your screen.

For more information about QuickSet, right-click the QuickSet icon and select **Help**.

---

[Back to Contents Page](#)

## Adding and Replacing Parts

### Dell™ Latitude™ D610 User's Guide

- [Before You Begin](#)
  - [Memory](#)
  - [Modem](#)
  - [Mini PCI Card](#)
  - [Hard Drive](#)
  - [Keyboard](#)
  - [Internal Card With Bluetooth® Wireless Technology](#)
  - [Coin-Cell Battery](#)
- 

## Before You Begin

This chapter provides procedures for removing and installing the components in your computer. Unless otherwise noted, each procedure assumes that the following conditions exist:

- 1 You have performed the steps in "[Turning Off Your Computer](#)" and "[Before Working Inside Your Computer](#)."
- 1 You have read the safety information in your Dell™ *Product Information Guide*.
- 1 A component can be replaced or—if purchased separately—installed by performing the removal procedure in reverse order.

## Recommended Tools

The procedures in this document may require the following tools:

- 1 Small flat-blade screwdriver
- 1 Phillips screwdriver
- 1 Small plastic scribe
- 1 Flash BIOS update program floppy or CD

## Turning Off Your Computer

 **NOTICE:** To avoid losing data, save and close any open files and exit any open programs before you turn off your computer.

1. Shut down the operating system:
  - a. Save and close any open files, exit any open programs, click the **Start** button, and then click **Turn Off Computer**.
  - b. In the **Turn off computer** window, click **Turn off**.

The computer turns off after the operating system shutdown process finishes.

2. Ensure that the computer and any attached devices are turned off. If your computer and attached devices did not automatically turn off when you shut down your operating system, press and hold the power button for 4 seconds.

## Before Working Inside Your Computer

Use the following safety guidelines to help protect your computer from potential damage and to help ensure your own personal safety.

 **CAUTION:** Before you begin any of the procedures in this section, follow the safety instructions in the *Product Information Guide*.

 **CAUTION:** Handle components and cards with care. Do not touch the components or contacts on a card. Hold a card by its edges or by its metal mounting bracket. Hold a component such as a processor by its edges, not by its pins.

 **NOTICE:** Only a certified service technician should perform repairs on your computer. Damage due to servicing that is not authorized by Dell is not covered by your warranty.

 **NOTICE:** When you disconnect a cable, pull on its connector or on its strain-relief loop, not on the cable itself. Some cables have a connector with locking tabs; if you are disconnecting this type of cable, press in on the locking tabs before you disconnect the cable. As you pull connectors apart, keep them evenly aligned to avoid bending any connector pins. Also, before you connect a cable, ensure that both connectors are correctly oriented and aligned.

 **NOTICE:** To avoid damaging the computer, perform the following steps before you begin working inside the computer.

1. Ensure that the work surface is flat and clean to prevent the computer cover from being scratched.



2. [Turn off your computer.](#)
3. If the computer is connected to a docking device (docked), undock it. See the documentation that came with your docking device for instructions.
- 🔑 **NOTICE:** To disconnect a network cable, first unplug the cable from your computer and then unplug it from the network wall jack.
4. Disconnect any telephone or network cables from the computer.
5. Close the display and turn the computer upside down on a flat work surface.
- 🔑 **NOTICE:** To avoid damaging the system board, you must remove the main battery before you service the computer.
6. Remove any installed modules, including a second battery, if installed.
7. Disconnect your computer and all attached devices from their electrical outlets, slide and hold the battery-bay latch release on the bottom of the computer and remove the battery from the bay, and then press the power button to ground the system board.
8. Remove any installed PC Cards from the PC Card slot.
9. Remove the [hard drive](#).

---

## Memory

You can increase your computer memory by installing memory modules on the system board. See "[Specifications](#)" for information on the memory supported by your computer. Install only memory modules that are intended for your computer.

⚠️ **CAUTION:** Before you begin any of the procedures in this section, follow the safety instructions in the *Product Information Guide*.

🔑 **NOTICE:** If your computer has only one memory module, install the memory module in the connector labeled "DIMMA."

🔑 **NOTICE:** If you remove your original memory modules from the computer during a memory upgrade, keep them separate from any new modules that you may have, even if you purchased the new modules from Dell. If possible, *do not* pair an original memory module with a new memory module. Otherwise, your computer may not function at optimal performance.

📌 **NOTE:** Memory modules purchased from Dell are covered under your computer warranty.

Your computer has two user-accessible SODIMM sockets, one accessed from beneath the keyboard (DIMM A), and the other accessed from the bottom of the computer (DIMM B).

To add or replace a memory module in the DIMM A connector:

1. Follow the procedures in "[Before You Begin](#)."
2. Remove the [keyboard](#).



1 memory module (DIMM A)

🔑 **NOTICE:** To prevent damage to the memory module connector, do not use tools to spread the memory-module securing clips.

3. If you are replacing a memory module, ground yourself and remove the existing module:
  - a. Use your fingertips to carefully spread apart the securing clips on each end of the memory module connector until the module pops up.
  - b. Remove the module from the connector.

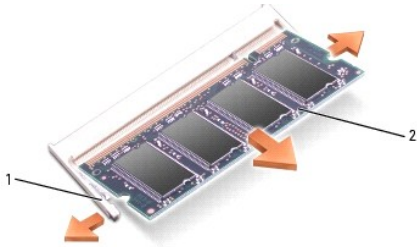

1	securing clips (2 per connector)
2	memory module

**NOTICE:** If you need to install memory modules in two connectors, install a memory module in the connector labeled "DIMMA" before you install a module in the connector labeled "DIMMB." Insert memory modules at a 45-degree angle to avoid damaging the connector.

4. Ground yourself and install the new memory module:

**NOTE:** If the memory module is not installed properly, the computer may not boot properly. No error message indicates this failure.

- a. Align the notch in the module edge connector with the tab in the connector slot.
- b. Slide the module firmly into the slot at a 45-degree angle, and rotate the module down until it clicks into place. If you do not feel the click, remove the module and reinstall it.

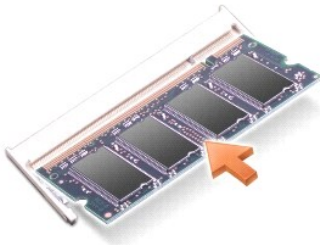

To add or replace a memory module in the DIMM B connector:

1. Follow the procedures in ["Before You Begin."](#)
2. Turn the computer over, loosen the captive screw in the memory module cover, and then remove the cover.



1	captive screw
---	---------------

➡ **NOTICE:** To prevent damage to the memory module connector, do not use tools to spread the memory-module securing clips.

3. If you are replacing a memory module, ground yourself and remove the existing module:
  - a. Use your fingertips to carefully spread apart the securing clips on each end of the memory module connector until the module pops up.
  - b. Remove the module from the connector.

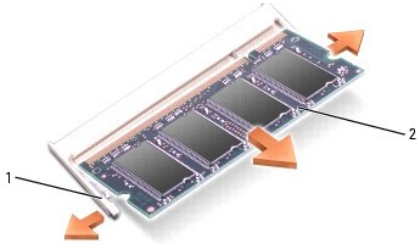

1	securing clips (2 per connector)
2	memory module

➡ **NOTICE:** If you need to install memory modules in two connectors, install a memory module in the connector labeled "DIMMA" before you install a module in the connector labeled "DIMMB." Insert memory modules at a 45-degree angle to avoid damaging the connector.

4. Ground yourself and install the new memory module:

🔧 **NOTE:** If the memory module is not installed properly, the computer may not boot properly. No error message indicates this failure.

- a. Align the notch in the module edge connector with the tab in the connector slot.
- b. Slide the module firmly into the slot at a 45-degree angle, and rotate the module down until it clicks into place. If you do not feel the click, remove the module and reinstall it.

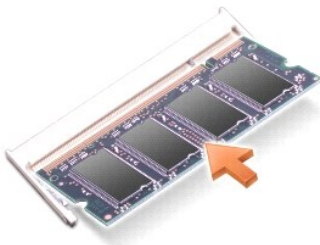

5. Replace the cover.

➡ **NOTICE:** If the cover is difficult to close, remove the module and reinstall it. Forcing the cover to close may damage your computer.

6. Insert the battery into the battery bay, or connect the AC adapter to your computer and an electrical outlet.
7. Turn on the computer.

As the computer boots, it detects the additional memory and automatically updates the system configuration information.

To confirm the amount of memory installed in the computer:

1. Click the **Start** button, click **Help and Support**, and then click **Computer Information**.

---

## Modem

If you ordered the optional modem at the same time that you ordered your computer, the modem is already installed.

⚠ **CAUTION:** Before you begin any of the procedures in this section, follow the safety instructions in the *Product Information Guide*.

1. Follow the procedures in "[Before You Begin.](#)"
2. Turn the computer over and release the captive screw from the modem cover.



1	captive screw
---	---------------

3. Place your finger under the cover at the indentation and lift the cover open.



1	screw
2	modem
3	coin-cell battery

4. If a modem is not already installed, go to [step 5](#). If you are replacing a modem, remove the existing modem:
  - a. Remove the screw that secures the modem to the system board, and set the screw aside.
  - b. Pull straight up on the attached pull-tab to lift the modem out of its connector on the system board, and disconnect the modem cable.
5. Connect the modem cable to the modem.

**NOTICE:** The connectors are keyed to ensure correct insertion. If you feel resistance, check the connectors and realign the card.

6. Align the modem with the screw hole and press the modem into the connector on the system board.
  7. Install the screw to secure the modem to the system board.
  8. Replace the cover.
-

## Mini PCI Card

If you ordered a Mini PCI card with your computer, the card is already installed.

**⚠ CAUTION:** Before you begin any of the procedures in this section, follow the safety instructions in the *Product Information Guide*.

1. Follow the procedures in "[Before You Begin](#)."
2. Remove the [keyboard](#).

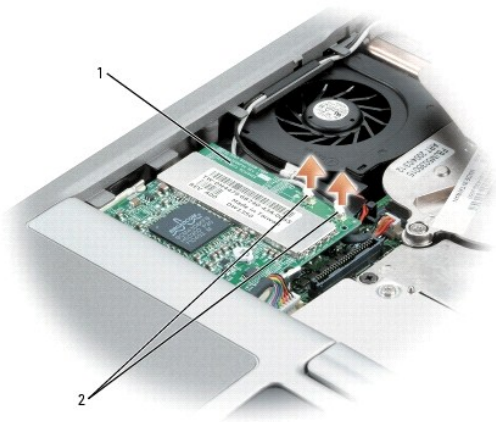

1	Mini PCI card
2	antenna wires (2)

3. If a Mini PCI card is not already installed, go to [step 4](#). If you are replacing a Mini PCI card, remove the existing card:
  - a. Disconnect the Mini PCI card from any attached cables.



1	Mini PCI card
2	metal securing tabs (2)

- b. Release the Mini PCI card by spreading the metal securing tabs until the card pops up slightly.
- c. Lift the Mini PCI card out of its connector.

**➡ NOTICE:** The connectors are keyed to ensure correct insertion. If you feel resistance, check the connectors and realign the card.



1	Mini PCI card
2	metal securing tabs (2)

- Align the Mini PCI card with the connector at a 45-degree angle, and press the Mini PCI card into the connector until you feel a click.

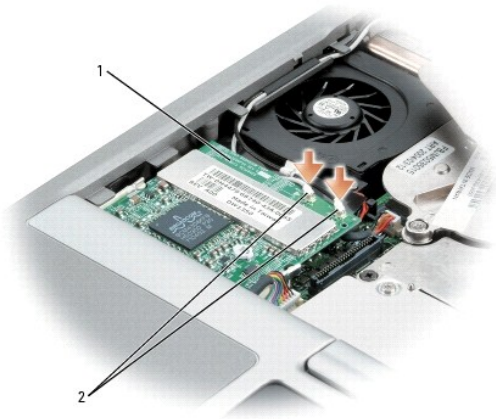

1	Mini PCI card
2	antenna wires (2)

- NOTICE:** To avoid damaging the Mini PCI card, never place cables on top of or under the card.

- Connect the antenna cables to the Mini PCI card.
- Replace the cover and screws.

## Hard Drive

- CAUTION:** If you remove the hard drive from the computer when the drive is hot, *do not touch* the metal housing of the hard drive.
- CAUTION:** Before working inside your computer, follow the safety instructions in the *Product Information Guide*.
- NOTICE:** To prevent data loss, [turn off your computer](#) before removing the hard drive. Do not remove the hard drive while the computer is on, in standby mode, or in hibernate mode.

➔ **NOTICE:** Hard drives are extremely fragile; even a slight bump can damage the drive.

🔧 **NOTE:** Dell does not guarantee compatibility or provide support for hard drives from sources other than Dell.

To replace the hard drive in the hard drive bay:

1. Follow the procedures in "[Before You Begin.](#)"

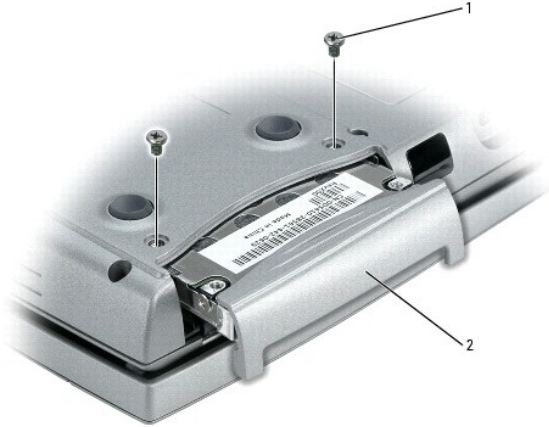

1	screws (2)
2	hard drive

2. Turn the computer over, and remove the hard drive screws.

➔ **NOTICE:** When the hard drive is not in the computer, store it in protective antistatic packaging. See "Protecting Against Electrostatic Discharge" in the *Product Information Guide*.

3. Slide the hard drive out of the computer.
4. Remove the new drive from its packaging.

Save the original packaging for storing or shipping the hard drive.

➔ **NOTICE:** Use firm and even pressure to slide the drive into place. If you use excessive force, you may damage the connector.

5. Slide the hard drive into the bay until it is fully seated.
6. Replace and tighten the screws.
7. Use the *Operating System* CD to install the [operating system](#) for your computer.
8. Use the *Drivers and Utilities* CD to install the [drivers and utilities](#) for your computer.

---

## Keyboard

⚠ **CAUTION:** Before performing the following procedures, read the safety instructions in your *Product Information Guide*.

➔ **NOTICE:** To avoid electrostatic discharge, ground yourself by using a wrist grounding strap or by periodically touching an unpainted metal surface (such as the back panel) on the computer.

1. Follow the instructions in "[Before You Begin.](#)"
2. Turn the computer right-side up and open it.



1	display
2	center control cover
3	computer base

3. Remove the center control cover:

- a. Open the display all the way (180 degrees) so that it lies flat against your work surface.
- b. Starting on the right side of the computer, use a plastic scribe to pry up the center control cover. Lift it away from the computer, and lay it aside.



1	center control cover
---	----------------------

4. Remove the keyboard:

- a. Remove the two M2.5 x 6-mm screws across the top of the keyboard.

 **NOTICE:** The keycaps on the keyboard are fragile, easily dislodged, and time-consuming to replace. Be careful when removing and handling the keyboard.

 **NOTE:** Lift the keyboard carefully in [step b](#) to ensure that you do not pull on the keyboard wire.

- b. Rotate the keyboard up 90-degrees and slide it forward to gain access to the keyboard connector.
- c. Pull up on the keyboard connector tab to disconnect the keyboard connector from the system board.

 **NOTE:** When you replace the keyboard, ensure that the keyboard tabs are completely in place to avoid scratching the palm rest.





1	M2.5 x 6-mm screws (2)
2	keyboard connector pull-tab
3	keyboard tabs
4	palm rest

## Internal Card With Bluetooth® Wireless Technology

**⚠ CAUTION:** Before performing the following procedures, read the safety instructions in your *Product Information Guide*.

**➡ NOTICE:** To avoid electrostatic discharge, ground yourself by using a wrist grounding strap or by periodically touching a connector on the back panel of the computer.

**➡ NOTICE:** To avoid damaging the system board, you must remove the main battery before you begin working inside the computer.

If you ordered an internal card with Bluetooth wireless technology with your computer, it is already installed.

1. Remove the battery.
2. Open the card door.
3. Using a plastic scribe or screwdriver, gently pry the module from the plastic guide bracket and the compartment so that you can disconnect the card from its cable and remove it from the computer.

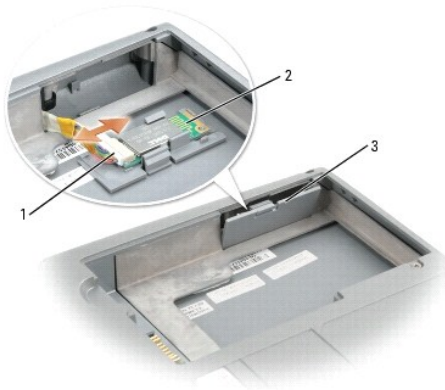

1	card connector
2	card
3	door

## Coin-Cell Battery

**⚠ CAUTION:** Before performing the following procedures, read the safety instructions in your *Product Information Guide*.

**➡ NOTICE:** To avoid electrostatic discharge, ground yourself by using a wrist grounding strap or by periodically touching a connector on the back panel of the computer.

**➡ NOTICE:** To avoid damaging the system board, you must remove the main battery before you begin working inside the computer.

1. Follow the procedures in "[Before You Begin](#)."
2. Turn the computer over and release the captive screw on the modem cover.
3. Place your finger under the cover at the indentation and lift the cover open.



1	captive screw
---	---------------

**➡ NOTICE:** To avoid damaging the system board, make sure you do not remove the plastic film between the battery and the system board as you remove the double-sided tape from the coin-cell battery.

**➡ NOTICE:** To avoid damaging the system board or modem card, retain the double-sided tape and secure the replacement coin-cell battery to the plastic film between the battery and the system board.

4. Gently draw the coin-cell battery from the coin-cell-battery pocket, and disconnect the battery cable.



1	coin-cell battery
2	cable connector
3	battery cable connector
4	coin-cell battery pocket

5. Replace the cover.
-

[Back to Contents Page](#)

## Using the System Setup Program

### Dell™ Latitude™ D610 User's Guide

- [Overview](#)
  - [Viewing the System Setup Screens](#)
  - [System Setup Screen](#)
  - [Commonly Used Options](#)
- 

## Overview

 **NOTE:** Your operating system may automatically configure most of the options available in system setup, thus overriding options that you set through system setup. (An exception is the **External Hot Key** option, which you can disable or enable only through system setup.) For more information on configuring features for your operating system, see the [Windows Help and Support Center](#).

You can use system setup as follows:

- 1 To set or change user-selectable features—for example, your computer password
- 1 To verify information about the computer's current configuration, such as the amount of system memory

After you set up the computer, run system setup to familiarize yourself with your system configuration information and optional settings. You may want to write down the information for future reference.

The system setup screens display the current setup information and settings for your computer, such as:

- 1 System configuration
- 1 Boot order
- 1 Boot (start-up) configuration and docking-device configuration settings
- 1 Basic device-configuration settings
- 1 System security and hard-drive password settings

 **NOTICE:** Unless you are an expert computer user or are directed to do so by Dell technical support, do not change the system setup settings. Certain changes might make your computer work incorrectly.

---

## Viewing the System Setup Screens

1. Turn on (or restart) your computer.
  2. When the DELL™ logo appears, press <F2> immediately. If you wait too long and the Windows logo appears, continue to wait until you see the Windows desktop. Then shut down your computer and try again.
- 

## System Setup Screen

The **System Setup** screen consists of three panes. The left pane contains a menu of control categories. To show or hide subcategories, select a category (such as **System**, **Onboard Devices**, or **Video**) and press the <Enter> key. The right pane displays information about the category or subcategory.

The bottom pane describes how to control system setup with key functions. Use the keys to select a category, modify settings, or exit system setup.

---

## Commonly Used Options

Certain options require that you reboot the computer for new settings to take effect.

## Changing the Boot Sequence

The *boot sequence*, or *boot order*, tells the computer where to look to find the software needed to start the operating system. You can control the boot sequence and enable/disable devices using the **Boot Order** page of system setup.

 **NOTE:** To change the boot sequence on a one-time-only basis, see "[Performing a One-Time Boot](#)."

The **Boot Order** page displays a general list of the bootable devices that may be installed in your computer, including but not limited to the following:

- 1 **Diskette Drive**
- 1 **Modular Bay HDD**
- 1 **Internal HDD**
- 1 **CD/DVD/CD-RW Drive**

During the boot routine, the computer starts at the top of the list and scans each enabled device for the operating system start-up files. When the computer finds the files, it stops searching and starts the operating system.

To control the boot devices, select (highlight) a device by pressing the down-arrow or up-arrow key, and then enable or disable the device or change its order in the list.

- 1 To enable or disable a device, highlight the item and press the space bar. Enabled items appear as white and display a small triangle to the left; disabled items appear blue or dimmed without a triangle.
- 1 To reorder a device in the list, highlight the device and then press <u> or <d> (not case-sensitive) to move the highlighted device up or down.

Boot sequence changes take effect as soon as you save the changes and exit system setup.

## Performing a One-Time Boot

You can set a one-time-only boot sequence without entering system setup. (You can also use this procedure to boot the Dell Diagnostics on the diagnostics utility partition on your hard drive.)

1. Shut down the computer through the **Start** menu.
2. If the computer is connected to a docking device (docked), undock it. See the documentation that came with your docking device for instructions.
3. Connect the computer to an electrical outlet.
4. Turn on the computer. When the DELL logo appears, press <F12> immediately. If you wait too long and the Windows logo appears, continue to wait until you see the Windows desktop. Then shut down your computer and try again.
5. When the boot device list appears, highlight the device from which you want to boot and press <Enter>.

The computer boots to the selected device.

The next time you reboot the computer, the previous boot order is restored.

## Changing Printer Modes

Set the **Parallel Mode** option according to the type of printer or device connected to the parallel connector. To determine the correct mode to use, see the documentation that came with the device.

Setting **Parallel Mode** to **Disabled** disables the parallel port and the port's LPT address, which frees computer resources for another device to use.

## Changing COM Ports

**Serial Port** allows you to map the serial port COM address or disable the serial port and its address, which frees computer resources for another device to use.

## Enabling the Infrared Sensor

1. Under **Onboard Devices**, select **Fast IR**.
2. Press <Enter> to select the **Fast IR** setting, and use the right-arrow or left-arrow keys to change the setting to a COM port.

 **NOTE:** The default setting is **Off**.

3. Press <Enter> and then <Esc> to save the changes and exit the system setup program.

After you enable the infrared sensor, you can use it to establish a link to an infrared device. To set up and use an infrared device, see the infrared device documentation and the [Windows Help and Support Center](#).



## Using Smart Cards

### Dell™ Latitude™ D610 User's Guide

- [About Smart Cards](#)
- [Installing a Smart Card](#)

 **NOTE:** This feature may not be available on your computer.

---

## About Smart Cards

Smart cards are portable credit-card shaped devices with internal integrated circuits. The top surface of the smart card usually contains an embedded processor located under the gold contact pad. The combination of the small size and integrated circuits make smart cards valuable tools for security, data storage, and special programs. Using smart cards can improve system security by combining something a user has (the smart card) with something only the user should know (a PIN) to provide more secure user-authentication than passwords alone.

---

## Installing a Smart Card

You can install a smart card in the computer while the computer is running. The computer automatically detects the card.

To install a smart card:

1. Hold the card so that the gold contact pad is facing upward and pointing toward the smart card slot.

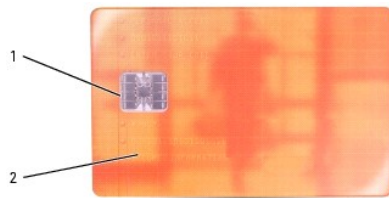

1	gold contact pad
2	smart card (top)

2. Slide the smart card into the smart card slot until the card is completely seated in its connector. The smart card will protrude approximately 1/2 inch from the slot. The smart card slot is located below the PC Card slot.

If you encounter too much resistance, do not force the card. Check the card orientation and try again.

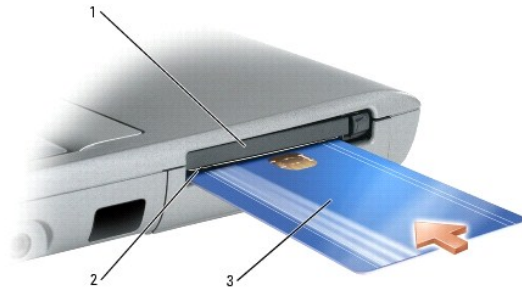

1	PC Card slot
2	smart card slot
3	smart card

---

[Back to Contents Page](#)

## Solving Problems

Dell™ Latitude™ D610 User's Guide

- [Dell Technical Update Service](#)
- [Dell Support Utility](#)
- [Drive Problems](#)
- [E-Mail, Modem, and Internet Problems](#)
- [Error Messages](#)
- [IEEE 1394 Device Problems](#)
- [Keyboard Problems](#)
- [Lockups and Software Problems](#)
- [Memory Problems](#)
- [Network Problems](#)
- [PC Card Problems](#)
- [Power Problems](#)
- [Printer Problems](#)
- [Scanner Problems](#)
- [Sound and Speaker Problems](#)
- [Touch Pad or Mouse Problems](#)
- [Video and Display Problems](#)

---

### Dell Technical Update Service

The Dell Technical Update service provides proactive e-mail notification of software and hardware updates for your computer. The service is free and can be customized for content, format, and how frequently you receive notifications.

To enroll for the Dell Technical Update service, go to [support.dell.com/technicalupdate](http://support.dell.com/technicalupdate).

---

### Dell Support Utility

The Dell Support Utility is installed on your computer and available from the Dell Support icon on the taskbar or from the **Start** button. Use this support utility for self-support information, software updates, and health scans of your computing environment.

### Accessing the Dell Support Utility

Access the Dell Support Utility from the Dell Support icon on the taskbar or from the **Start** menu.

If the Dell Support icon does not appear in your taskbar:

1. Click the **Start** button and point to **Programs**.
2. Click **Dell Support** and point to **Dell Support Settings**.
3. Ensure that the **Show icon on the taskbar** option is checked.

 **NOTE:** If the Dell Support Utility is not available from the **Start** menu, go to [support.dell.com](http://support.dell.com) and download the software.

The Dell Support Utility is customized for your computing environment.

The Dell Support icon in the taskbar functions differently when you click, double-click, or right-click the icon.

### Clicking the Dell Support Icon

Click or right-click the  icon to perform the following tasks:

1. Check your computing environment
1. View the Dell Support Utility settings
1. Access the help file for the Dell Support Utility
1. View frequently asked questions
1. Learn more about the Dell Support Utility
1. Turn the Dell Support Utility off

### Double-Clicking the Dell Support Icon



Double-click the  icon to manually check your computing environment, view frequently asked questions, access the help file for the Dell Support Utility, and view Dell Support settings.

For more information about the Dell Support Utility, click the question mark (?) at the top of the Dell Support screen.

---

## Drive Problems

 **CAUTION:** Before you begin any of the procedures in this section, follow the safety instructions in the *Product Information Guide*.

Fill out the [Diagnostics Checklist](#) as you complete these checks.

<p><b>Ensure that Microsoft® Windows® recognizes the drive</b> — Click the <b>Start</b> button and click <b>My Computer</b>. If the floppy, CD, or DVD drive is not listed, perform a full scan with your antivirus software to check for and remove viruses. Viruses can sometimes prevent Windows from recognizing the drive.</p>
---

<p><b>Test the drive</b> —</p>
--------------------------------

- |   |
|---|
| <ol style="list-style-type: none"><li>1. Insert another floppy, CD, or DVD to eliminate the possibility that the original one is defective.</li><li>1. Insert a bootable floppy and restart the computer.</li></ol> |
|---|

<p><b>Clean the drive or disk</b> — See "<a href="#">Cleaning Your Computer</a>."</p>
---

<p><b>Ensure that the CD is snapped onto the spindle</b></p>
--

<p><b>Check the cable connections</b></p>
---

<p>Check for <a href="#">hardware incompatibilities</a></p>
---

<p>Run the <a href="#">Using the Dell Diagnostics</a></p>
---

## CD and DVD drive problems

 **NOTE:** High-speed CD or DVD drive vibration is normal and may cause noise, which does not indicate a defect in the drive or the CD or DVD.

 **NOTE:** Because of different regions worldwide and different disc formats, not all DVD titles work in all DVD drives.

## Problems writing to a CD/DVD-RW drive

<p><b>Close other programs</b> — The CD/DVD-RW drive must receive a steady stream of data when writing. If the stream is interrupted, an error occurs. Try closing all programs before you write to the CD/DVD-RW.</p>
--

<p><b>Turn off Standby mode in Windows before writing to a CD/DVD-RW disc</b> — See "<a href="#">Power Management Modes</a>" or search for the keyword <i>standby</i> in the Windows Help and Support Center for information on power management modes.</p>
---

<p><b>Change the write speed to a slower rate</b> — See the help files for your CD or DVD creation software.</p>
--

## If you cannot eject the CD, CD-RW, DVD, or DVD+RW drive tray

- |   |
|---|
| <ol style="list-style-type: none"><li>1. Ensure that the computer is shut down.</li><li>2. Straighten a paper clip and insert one end into the eject hole at the front of the drive; push firmly until the tray is partially ejected.</li><li>3. Gently pull out the tray until it stops.</li></ol> |
|---|

## If you hear an unfamiliar scraping or grinding sound

- 1 Ensure that the sound is not caused by the program that is running.
- 1 Ensure that the disk or disc is inserted properly.

## Hard drive problems

**Allow the computer to cool before turning it on** — A hot hard drive may prevent the operating system from starting. Try allowing the computer to return to room temperature before turning it on.

### Run Check Disk —

1. Click the **Start** button and click **My Computer**.
2. Right-click **Local Disk C:**.
3. Click **Properties**.
4. Click the **Tools** tab.
5. Under **Error-checking**, click **Check Now**.
6. Click **Scan for and attempt recovery of bad sectors**.
7. Click **Start**.

MS-DOS®

Type scandisk x: at an MS-DOS prompt, where x is the hard drive letter, and then press <Enter>. Click the **Start** button and click **My Computer**.

## E-Mail, Modem, and Internet Problems

 **CAUTION:** Before you begin any of the procedures in this section, follow the safety instructions in the *Product Information Guide*.

 **NOTE:** Connect the modem to an analog telephone jack only. The modem does not operate while it is connected to a digital telephone network.

**Check the Microsoft Outlook® Express Security Settings** — If you cannot open your e-mail attachments:

1. In Outlook Express, click **Tools**, click **Options**, and then click **Security**.
2. Click **Do not allow attachments** to remove the checkmark.

### Check the telephone line connection —

#### Check the telephone jack —

#### Connect the modem directly to the telephone wall jack —

#### Use a different telephone line —

- 1 Verify that the telephone line is connected to the jack on the modem. (The jack has either a green label or a connector-shaped icon next to it.)
- 1 Ensure that you feel a click when you insert the telephone line connector into the modem.
- 1 Disconnect the telephone line from the modem and connect it to a telephone. Listen for a dial tone.
- 1 If you have other telephone devices sharing the line, such as an answering machine, fax machine, surge protector, or line splitter, then bypass them and use the telephone to connect the modem directly to the telephone wall jack. If you are using a line that is 3 m (10 ft) or more in length, try a shorter one.

**Run the Modem Helper diagnostics** — Click the **Start** button, point to **All Programs**, and then click **Modem Helper**. Follow the instructions on the screen to identify and resolve modem problems. (Modem Helper is not available on all computers.)

### Verify that the modem is communicating with Windows —

1. Click the **Start** button and click **Control Panel**.
2. Click **Printers and Other Hardware**.
3. Click **Phone and Modem Options**.
4. Click the **Modems** tab.
5. Click the COM port for your modem.
6. Click **Properties**, click the **Diagnostics** tab, and then click **Query Modem** to verify that the modem is communicating with Windows.

**Ensure that you are connected to the Internet** — Ensure that you have subscribed to an Internet provider. With the Outlook Express e-mail program open, click **File**. If **Work Offline** has a checkmark next to it, click the checkmark to remove it and connect to the Internet. For help, contact your Internet service provider.

**Scan the computer for spyware** — If you are experiencing slow computer performance, you frequently receive pop-up advertisements, or you are having problems connecting to the Internet, your computer might be infected with spyware. Use an anti-virus program that includes anti-spyware protection (your program may require an upgrade) to scan the computer and remove spyware. For more information, go to [support.dell.com](http://support.dell.com) and search for the keyword *spyware*.

## Error Messages

Fill out the [Diagnostics Checklist](#) as you complete these checks.

 **CAUTION:** Before you begin any of the procedures in this section, follow the safety instructions in the *Product Information Guide*.

If the message is not listed, see the documentation for the operating system or the program that was running when the message appeared.

**Auxiliary device failure** — The touch pad, track stick, or external mouse may be faulty. For an external mouse, check the cable connection. Enable the Pointing Device option in the system setup program. If the problem persists, [contact Dell](#).

**Bad command or file name** — Ensure that you have spelled the command correctly, put spaces in the proper place, and used the correct pathname.

**Cache disabled due to failure** — The primary cache internal to the microprocessor has failed. [Contact Dell](#).

**CD drive controller failure** — The CD drive does not respond to commands from the computer. See "[Drive Problems](#)."

**Data error** — The hard drive cannot read the data. See "[Drive Problems](#)."

**Decreasing available memory** — One or more memory modules may be faulty or improperly seated. [Reinstall the memory modules](#) and, if necessary, replace them.

**Disk C: failed initialization** — The hard drive failed initialization. Run the hard drive tests as described in "[Using the Dell Diagnostics](#)."

**Drive not ready** — The operation requires a hard drive in the bay before it can continue. Install a [hard drive](#) in the hard drive bay.

**Error reading PCMCIA card** — The computer cannot identify the PC Card. Reinsert the card or try another [PC Card](#).

**Extended memory size has changed** — The amount of memory recorded in NVRAM does not match the memory installed in the computer. Restart the computer. If the error appears again [contact Dell](#).

**Gate A20 failure** — A memory module may be loose. Reinstall the [memory modules](#) and, if necessary, replace them.

**General failure** — The operating system is unable to carry out the command. The message is usually followed by specific information—for example, `Printer out of paper`. Take the appropriate action.

**Hard-disk drive configuration error** — The computer cannot identify the drive type. Shut down the computer, remove the [hard drive](#), and boot the computer from a CD. Then shut down the computer, reinstall the hard drive, and restart the computer. Run the Hard-Disk Drive tests as described in "[Using the Dell Diagnostics](#)."

**Hard-disk drive controller failure 0** — The hard drive does not respond to commands from the computer. Shut down the computer, remove the [hard drive](#), and boot the computer from a CD. Then shut down the computer, reinstall the hard drive, and restart the computer. If the problem persists, try another drive. Run the Hard-Disk Drive tests as described in "[Using the Dell Diagnostics](#)."

**Hard-disk drive failure** — The hard drive does not respond to commands from the computer. Shut down the computer, remove the [hard drive](#), and boot the computer from a CD. Then shut down the computer, reinstall the hard drive, and restart the computer. If the problem

persists, try another drive. Run the Hard-Disk Drive tests as described in "[Using the Dell Diagnostics](#)."

**Hard-disk drive read failure** — The hard drive may be defective. Shut down the computer, remove the [hard drive](#), and boot the computer from a CD. Then shut down the computer, reinstall the hard drive, and restart the computer. If the problem persists, try another drive. Run the Hard-Disk Drive tests as described in "[Using the Dell Diagnostics](#)."

**Insert bootable media** — The operating system is trying to boot to a nonbootable CD. Insert a bootable CD.

**Invalid configuration information-please run System Setup Program** — The system configuration information does not match the hardware configuration. The message is most likely to occur after a memory module is installed. Correct the appropriate options in the [system setup](#) program.

**Keyboard clock line failure** — For external keyboards, check the cable connection. Run the Keyboard Controller test as described in "[Using the Dell Diagnostics](#)."

**Keyboard controller failure** — For external keyboards, check the cable connection. Restart the computer, and avoid touching the keyboard or the mouse during the boot routine. Run the Keyboard Controller test as described in "[Using the Dell Diagnostics](#)."

**Keyboard data line failure** — For external keyboards, check the cable connection. Run the Keyboard Controller test as described in "[Using the Dell Diagnostics](#)."

**Keyboard stuck key failure** — For external keyboards or keypads, check the cable connection. Restart the computer, and avoid touching the keyboard or keys during the boot routine. Run the Stuck Key test as described in "[Using the Dell Diagnostics](#)."

**Memory address line failure at address, read value expecting value** — A memory module may be faulty or improperly seated. Reinstall the [memory modules](#) and, if necessary, replace them.

**Memory allocation error** — The software you are attempting to run is conflicting with the operating system, another program, or a utility. Shut down the computer, wait 30 seconds, and then restart it. Try to run the program again. If the error message still appears, see the software documentation.

**Memory data line failure at address, read value expecting value** — A memory module may be faulty or improperly seated. Reinstall the [memory modules](#) and, if necessary, replace them.

**Memory double word logic failure at address, read value expecting value** — A memory module may be faulty or improperly seated. Reinstall the [memory modules](#) and, if necessary, replace them.

**Memory odd/even logic failure at address, read value expecting value** — A memory module may be faulty or improperly seated. Reinstall the [memory modules](#) and, if necessary, replace them.

**Memory write/read failure at address, read value expecting value** — A memory module may be faulty or improperly seated. Reinstall the [memory modules](#) and, if necessary, replace them.

**No boot device available** — The computer cannot find the hard drive. If the hard drive is your boot device, ensure that the drive is installed, properly seated, and partitioned as a boot device.

**No boot sector on hard drive** — The operating system may be corrupted. [Contact Dell](#).

**No timer tick interrupt** — A chip on the system board may be malfunctioning. Run the System Set tests as described in "[Using the Dell Diagnostics](#)."

**Operating system not found** — Reinstall the [hard drive](#). If the problem persists, contact Dell.

**Optional ROM bad checksum** — The optional ROM apparently failed. [Contact Dell](#).

**A required .DLL file was not found** — The program that you are trying to open is missing an essential file. Remove and then reinstall the program.

1. Click the **Start** button and click **Control Panel**.
2. Click **Add or Remove Programs**.
3. Select the program you want to remove.

<p>4. Click <b>Remove</b> or <b>Change/Remove</b> and follow the prompts on the screen.</p> <p>5. See the program documentation for installation instructions.</p>
<p><b>Sector not found</b> — The operating system cannot locate a sector on the hard drive. You may have a defective sector or corrupted FAT on the hard drive. Run the Windows error-checking utility to check the file structure on the hard drive. See the Help and Support Center for instructions. If a large number of sectors are defective, back up the data (if possible), and then reformat the hard drive.</p>
<p><b>Seek error</b> — The operating system cannot find a specific track on the hard drive.</p>
<p><b>Shutdown failure</b> — A chip on the system board may be malfunctioning. Run the System Set tests as described in "<a href="#">Using the Dell Diagnostics</a>."</p>
<p><b>Time-of-day clock lost power</b> — System configuration settings are corrupted. If the problem persists, try to restore the data by entering the system setup program. Then immediately exit the program. See "<a href="#">Using the System Setup Program</a>." If the message reappears, <a href="#">contact Dell</a>.</p>
<p><b>Time-of-day clock stopped</b> — The coin-cell battery that supports the system configuration settings may no longer hold a charge. Replace the coin-cell battery (see "<a href="#">Adding and Replacing Parts</a>"), or connect your computer to an electrical outlet. If the problem persists, <a href="#">contact Dell</a>.</p>
<p><b>Time-of-day not set—please run the System Setup program</b> — The time or date stored in the system setup program does not match the system clock. Correct the settings for the <b>Date</b> and <b>Time</b> options. See "<a href="#">Using the System Setup Program</a>."</p>
<p><b>Timer chip counter 2 failed</b> — A chip on the system board may be malfunctioning. Run the System Set tests as described in "<a href="#">Using the System Setup Program</a>."</p>
<p><b>Unexpected interrupt in protected mode</b> — The keyboard controller may be malfunctioning, or a memory module may be loose. Run the System Memory tests and the Keyboard Controller test as described in "<a href="#">Using the Dell Diagnostics</a>."</p>
<p><b>x:\ is not accessible. The device is not ready</b> — Insert a disk into the drive and try again.</p>
<p><b>Warning: Battery is critically low</b> — The battery is running out of charge. Replace the battery, or connect the computer to an electrical outlet. Otherwise, activate hibernate mode or shut down the computer.</p>

## IEEE 1394 Device Problems

 **CAUTION:** Before you begin any of the procedures in this section, follow the safety instructions in the *Product Information Guide*.

<p><b>Ensure that the IEEE 1394 device is properly inserted into the connector</b></p>
<p><b>Ensure that the IEEE 1394 device is recognized by Windows</b> —</p> <ol style="list-style-type: none"> <li>1. Click the <b>Start</b> button and click <b>Control Panel</b>.</li> <li>2. Click <b>Printers and Other Hardware</b>.</li> </ol> <p>If your IEEE 1394 device is listed, Windows recognizes the device.</p>
<p><b>If you have problems with a Dell-provided IEEE 1394 device</b> —</p>
<p><b>If you have problems with an IEEE 1394 device not provided by Dell</b> —</p> <p><a href="#">Contact Dell</a> or the IEEE 1394 device manufacturer.</p>

## Keyboard Problems

 **CAUTION:** Before you begin any of the procedures in this section, follow the safety instructions in the *Product Information Guide*.

Fill out the [Diagnostics Checklist](#) as you perform the various checks.

 **NOTE:** Use the integrated keyboard when working in MS-DOS® mode or when running the Dell Diagnostics or the [system setup program](#). When you attach an external keyboard, the integrated keyboard remains fully functional.

## External keyboard problems

**Check the keyboard cable** — Shut down the computer. Disconnect the keyboard cable and check it for damage, and firmly reconnect the cable.

If you are using a keyboard extension cable, disconnect it and connect the keyboard directly to the computer.

### Check the external keyboard —

1. Shut down the computer, wait 1 minute, and turn it on again.
2. Verify that the numbers, capitals, and scroll lock lights on the keyboard blink during the boot routine.
3. From the Windows desktop, click the **Start** button, point to **Programs**, point to **Accessories**, and click **Notepad**.
4. Type some characters on the external keyboard and verify that they appear on the display.

If you cannot verify these steps, you may have a defective external keyboard.

### To verify that the problem is with the external keyboard, check the integrated keyboard —

1. Shut down the computer.
2. Disconnect the external keyboard.
3. Turn on the computer.
4. From the Windows desktop, click the **Start** button, point to **Programs**, point to **Accessories**, and click **Notepad**.
5. Type some characters on the external keyboard and verify that they appear on the display.

If the characters appear now but did not with the external keyboard, you may have a defective external keyboard. [Contact Dell](#).

**Run the keyboard diagnostics tests** — Run the PC-AT Compatible Keyboards tests in the Dell Diagnostics. If the tests indicate a defective external keyboard, [contact Dell](#).

## Unexpected characters

**Disable the numeric keypad** — Press <Num Lk> to disable the numeric keypad if numbers are displayed instead of letters. Verify that the numbers lock light is not lit.

## Lockups and Software Problems

 **CAUTION:** Before you begin any of the procedures in this section, follow the safety instructions in the *Product Information Guide*.

### The computer does not start up

Ensure that the AC adapter is firmly connected to the computer and to the electrical outlet.

### The computer stops responding

 **NOTICE:** You might lose data if you are unable to perform an operating system shutdown.

**Turn the computer off** — If you are unable to get a response by pressing a key on your keyboard or moving your mouse, press and hold the power button for at least 8 to 10 seconds until the computer turns off. Then restart your computer.

### A program stops responding

#### End the program —

1. Press <Ctrl><Shift><Esc> simultaneously.
2. Click **Applications**.
3. Click the program that is no longer responding.
4. Click **End Task**.

## A program crashes repeatedly

 **NOTE:** Software usually includes installation instructions in its documentation or on a floppy or CD.

**Check the software documentation** — If necessary, uninstall and then reinstall the program.

## A program is designed for an earlier Microsoft® Windows® operating system

#### If you are using Windows XP, run the Program Compatibility Wizard —

The Program Compatibility Wizard configures a program so it runs in an environment similar to non-Windows XP operating system environments.

1. Click the **Start** button, point to **All Programs**→**Accessories**, and then click **Program Compatibility Wizard**.
2. In the welcome screen, click **Next**.
3. Follow the instructions on the screen.

## A solid blue screen appears

**Turn the computer off** — If you are unable to get a response by pressing a key on your keyboard or moving your mouse, press and hold the power button for at least 8 to 10 seconds until the computer turns off. Then restart your computer.

## Other software problems

#### Check the software documentation or contact the software manufacturer for troubleshooting information —

1. Ensure that the program is compatible with the operating system installed on your computer.
1. Ensure that your computer meets the minimum hardware requirements needed to run the software. See the software documentation for information.
1. Ensure that the program is installed and configured properly.
1. Verify that the device drivers do not conflict with the program.
1. If necessary, uninstall and then reinstall the program.

**Back up your files immediately.**

**Use a virus-scanning program to check the hard drive, floppy disks, or CDs.**

**Save and close any open files or programs and shut down your computer through the Start menu.**

**Scan the computer for spyware** — If you are experiencing slow computer performance, you frequently receive pop-up advertisements, or you are having problems connecting to the Internet, your computer might be infected with spyware. Use an anti-virus program that includes anti-spyware protection (your program may require an upgrade) to scan the computer and remove spyware. For more information, go to [support.dell.com](http://support.dell.com) and search for the keyword *spyware*.

**Run the [Dell Diagnostics](#)** — If all tests run successfully, the error condition is related to a software problem.

## Memory Problems

Fill out the [Diagnostics Checklist](#) as you complete these checks.

 **CAUTION:** Before you begin any of the procedures in this section, follow the safety instructions in the *Product Information Guide*.

### If you receive an insufficient memory message —

- 1 Save and close any open files and exit any open programs you are not using to see if that resolves the problem.
- 1 See the software documentation for minimum memory requirements. If necessary, install additional [memory](#).
- 1 Reseat the [memory modules](#) to ensure that your computer is successfully communicating with the memory.
- 1 Run the [Dell Diagnostics](#).

### If you experience other memory problems —

- 1 Reseat the [memory modules](#) to ensure that your computer is successfully communicating with the memory.
- 1 Ensure that you are following the [memory](#) installation guidelines.
- 1 Run the [Dell Diagnostics](#).

## Network Problems

Fill out the [Diagnostics Checklist](#) as you complete these checks.

 **CAUTION:** Before you begin any of the procedures in this section, follow the safety instructions in the *Product Information Guide*.

**Check the network cable connector** — Ensure that the network cable is firmly inserted into both the network connector on the back of the computer and the network jack.

**Check the network lights on the network connector** — No light indicates that no network communication exists. Replace the network cable.

**Restart the computer and log on to the network again.**

**Check your network settings** — Contact your network administrator or the person who set up your network to verify that your network settings are correct and that the network is functioning.

## PC Card Problems

 **CAUTION:** Before you begin any of the procedures in this section, follow the safety instructions in the *Product Information Guide*.

**Check the PC Card** — Ensure that the PC Card is properly inserted into the connector.

**Ensure that the card is recognized by Windows** — Double-click the **Safely Remove Hardware** icon in the Windows taskbar. Ensure that the card is listed.

**If you have problems with a Dell-provided PC Card** — [Contact Dell](#).

**If you have problems with a PC Card not provided by Dell** — Contact the PC Card manufacturer.

## Power Problems

Fill out the [Diagnostics Checklist](#) as you complete these checks.



 **CAUTION:** Before you begin any of the procedures in this section, follow the safety instructions in the *Product Information Guide*.

**Check the power light** — When the power light is lit or blinking, the computer has power. If the power light is blinking, the computer is in standby mode—press the power button to exit standby mode. If the light is off, press the power button to turn on the computer.

**Charge the battery** — The battery charge may be depleted.

1. Reinstall the battery.
2. Use the AC adapter to connect the computer to an electrical outlet.
3. Turn on the computer.

**Check the battery status light** — If the battery status light flashes orange or is a steady orange the battery charge is low or depleted. Connect the computer to an electrical outlet.

If the battery status light flashes green and orange, the battery is too hot to charge. Shut down the computer, disconnect the computer from the electrical outlet, and then let the battery and computer cool to room temperature.

If the battery status light rapidly flashes orange, the battery may be defective. [Contact Dell](#).

**Check the battery temperature** — If the battery temperature is below 0° C (32° F), the computer will not start up.

**Test the electrical outlet** — Ensure that the electrical outlet is working by testing it with another device, such as a lamp.

**Check the AC adapter** — Check the AC adapter cable connections. If the AC adapter has a light, ensure that the light is on.

**Connect the computer directly to an electrical outlet** — Bypass power protection devices, power strips, and the extension cable to verify that the computer turns on.

**Eliminate possible interference** — Turn off nearby fans, fluorescent lights, halogen lamps, or other appliances.

**Adjust the power properties** — See [Configuring Power Management Settings](#).

**Reseat the memory modules** — If the computer power light turns on but the display remains blank, reinstall the [memory modules](#).

## Ensuring Sufficient Power for Your Computer

Your computer is designed to use the 90-W AC adapter; for optimum system performance, you should always use this adapter.

The 65-W AC adapters used in other Dell™ portable computers can be used with your computer, but they will decrease system performance. Using less-powerful AC adapters, including the 65-W AC adapter, will cause you to receive a **WARNING** message.

## Docking Power Considerations

 **NOTE:** Ensure that your battery is charged before attempting to undock your computer.

 **NOTE:** When you undock your computer from the docking device, a solid black screen may appear, depending on the type of video adapter that you are using. This is expected behavior and does not indicate that a problem exists. See your docking device documentation for more information on undocking your computer.

Due to the extra power consumption when a computer is docked to the Dell D/Dock, normal computer operation is not possible on battery power alone. Ensure that the 90-W AC adapter is connected to the docking device when the computer is docked to the Dell D/Dock.

## Docking While the Computer Is Running

If a computer is connected to the Dell D/Dock or Dell D/Port while the computer is running, presence of the docking device is ignored until the AC adapter is connected to the computer.

## AC Power Loss While the Computer Is Docked

If a computer loses AC power while docked to the Dell D/Dock or Dell D/Port, the computer immediately goes into low-performance mode.

---

## Printer Problems

Fill out the [Diagnostics Checklist](#) as you complete these checks.

 **CAUTION:** Before you begin any of the procedures in this section, follow the safety instructions in the *Product Information Guide*.

 **NOTE:** If you need technical assistance for your printer, contact the printer's manufacturer.

<b>Check the printer documentation</b> — See the printer documentation for setup and troubleshooting information.
<b>Ensure that the printer is turned on.</b>
<b>Check the printer cable connections</b> — <ol style="list-style-type: none"><li>1. See the printer documentation for cable connection information.</li><li>1. Ensure that the printer cables are securely connected to the printer and the computer.</li></ol>
<b>Test the electrical outlet</b> — Ensure that the electrical outlet is working by testing it with another device, such as a lamp.
<b>Verify that the printer is recognized by Windows</b> —  <ol style="list-style-type: none"><li>1. Click the <b>Start</b> button, click <b>Control Panel</b>, and then click <b>Printers and Other Hardware</b>.</li><li>2. Click <b>View installed printers or fax printers</b>.  If the printer is listed, right-click the printer icon.</li><li>3. Click <b>Properties</b> and click the <b>Ports</b> tab. For a parallel printer, ensure that the <b>Print to the following port(s):</b> setting is <b>LPT1 (Printer Port)</b>. For a USB printer, ensure that the <b>Print to the following port(s):</b> setting is <b>USB</b>.</li></ol>
<b>Reinstall the printer driver</b> — See the printer documentation for instructions.

---

## Scanner Problems

 **CAUTION:** Before you begin any of the procedures in this section, follow the safety instructions in the *Product Information Guide*.

 **NOTE:** If you need technical assistance for your scanner, contact the scanner's manufacturer.

<b>Check the scanner documentation</b> — See the scanner documentation for setup and troubleshooting information.
<b>Unlock the scanner</b> — Ensure that your scanner is unlocked if it has a locking tab or button.
<b>Restart the computer and try the scanner again.</b>
<b>Check the cable connections</b> — <ol style="list-style-type: none"><li>1. See the scanner documentation for cable connection information.</li><li>1. Ensure that the scanner cables are securely connected to the scanner and the computer.</li></ol>
<b>Verify that the scanner is recognized by Microsoft Windows</b> —  <ol style="list-style-type: none"><li>1. Click the <b>Start</b> button, click <b>Control Panel</b>, and then click <b>Printers and Other Hardware</b>.</li><li>2. Click <b>Scanners and Cameras</b>.</li></ol>

If your scanner is listed, Windows recognizes the scanner.

**Reinstall the scanner driver** — See the scanner documentation for instructions.

## Sound and Speaker Problems

 **NOTE:** This computer uses digital sound, and contains no analog audio lines. PCMCIA cards such as modems that use analog lines to produce sound will not function.

Fill out the [Diagnostics Checklist](#) as you complete these checks.

 **CAUTION:** Before you begin any of the procedures in this section, follow the safety instructions in the *Product Information Guide*.

### No sound from integrated speakers

**Adjust the Windows volume control** — Double-click the speaker icon in the lower-right corner of your screen. Ensure that the volume is turned up and that the sound is not muted. Adjust the volume, bass, or treble controls to eliminate distortion.

**Adjust the volume using keyboard shortcuts** — Press <Fn><End> to disable (mute) or reenable the integrated speakers.

**Reinstall the sound (audio) driver** — See "[Reinstalling Drivers and Utilities](#)."

### No sound from external speakers

 **NOTE:** The volume control in some MP3 players overrides the Windows volume setting. If you have been listening to MP3 songs, ensure that you did not turn the player volume down or off.

**Ensure that the subwoofer and the speakers are turned on** — See the setup diagram supplied with the speakers. If your speakers have volume controls, adjust the volume, bass, or treble to eliminate distortion.

**Adjust the Windows volume control** — Click or double-click the speaker icon in the lower-right corner of your screen. Ensure that the volume is turned up and that the sound is not muted.

**Disconnect headphones from the headphone connector** — Sound from the speakers is automatically disabled when headphones are connected to the computer's front-panel headphone connector.

**Test the electrical outlet** — Ensure that the electrical outlet is working by testing it with another device, such as a lamp.

**Eliminate possible interference** — Turn off nearby fans, fluorescent lights, or halogen lamps to check for interference.

**Reinstall the audio driver**

Run the [Dell Diagnostics](#)

### No sound from headphones

**Check the headphone cable connection** — Ensure that the headphone cable is securely inserted into the [headphone connector](#).

**Adjust the Windows volume control** — Click or double-click the speaker icon in the lower-right corner of your screen. Ensure that the volume is turned up and that the sound is not muted.

## Touch Pad or Mouse Problems

### Check the touch pad settings —

1. Click the **Start** button, click **Control Panel**, and then click **Printers and Other Hardware**.
2. Click **Mouse**.
3. Try adjusting the settings.

**Check the mouse cable —** Shut down the computer. Disconnect the mouse cable, check it for damage, and firmly reconnect the cable.

If you are using a mouse extension cable, disconnect it and connect the mouse directly to the computer.

### To verify that the problem is with the mouse, check the touch pad —

1. Shut down the computer.
2. Disconnect the mouse.
3. Turn on the computer.
4. At the Windows desktop, use the touch pad to move the cursor around, select an icon, and open it.

If the touch pad operates correctly, the mouse may be defective.

**Check the system setup program settings —** Verify that the system setup program lists the correct device for the pointing device option. (The computer automatically recognizes a USB mouse without making any setting adjustments.)

**Test the mouse controller —** To test the mouse controller (which affects pointer movement) and the operation of the touch pad or mouse buttons, run the Mouse test in the **Pointing Devices** test group in the [Dell Diagnostics](#).

**Reinstall the touch pad driver —** See "[Reinstalling Drivers and Utilities](#)."

## Video and Display Problems

Fill out the [Diagnostics Checklist](#) as you complete these checks.

 **CAUTION:** Before you begin any of the procedures in this section, follow the safety instructions in the *Product Information Guide*.

### If the display is blank

 **NOTE:** If you are using a program that requires a higher resolution than your computer supports, it is recommended that you attach an external monitor to your computer.

**Check the battery —** If you are using a battery to power your computer, the battery charge may be depleted. Connect the computer to an electrical outlet using the AC adapter, and turn on the computer.

**Test the electrical outlet —** Ensure that the electrical outlet is working by testing it with another device, such as a lamp.

**Check the AC adapter —** Check the AC adapter cable connections. If the AC adapter has a light, ensure that the light is on.

**Connect the computer directly to an electrical outlet —** Bypass power protection devices, power strips, and the extension cable to verify that the computer turns on.

**Adjust the power properties —** Search for the keyword *standby* in the Windows Help and Support Center.

**Switch the video image —** If your computer is attached to an external monitor, press <Fn><F8> to switch the video image to the display.

### If the display is difficult to read

--

**Adjust the brightness** — Press <Fn> and the up- or down-arrow key.

**Move the external subwoofer away from the computer or monitor** — If your external speaker system includes a subwoofer, ensure that the subwoofer is at least 60 cm (2 ft) away from the computer or external monitor.

**Eliminate possible interference** — Turn off nearby fans, fluorescent lights, halogen lamps, or other appliances.

**Rotate the computer to face a different direction** — Eliminate sunlight glare, which can cause poor picture quality.

**Adjust the Windows display settings** —

1. Click the **Start** button and then click **Control Panel**.
2. Click **Appearance and Themes**.
3. Click the area you want to change or click the **Display** icon.
4. Try different settings for **Color quality** and **Screen resolution**.

**Run the Video diagnostics tests** — If no error message appears and you still have a display problem, but the display is not completely blank, run the **Video** device group in the [Dell Diagnostics](#). Then [contact Dell](#).

**See "Error Messages"** — If an error message appears, see "[Error Messages](#)."

## If only part of the display is readable

**Connect an external monitor** —

1. Shut down your computer and connect an external monitor to the computer.
2. Turn on the computer and the monitor and adjust the monitor brightness and contrast controls.

If the external monitor works, the computer display or video controller may be defective. [Contact Dell](#).

[Back to Contents Page](#)

## Specifications

### Dell™ Latitude™ D610 User's Guide

Processor	
Processor type	Intel® Pentium® M
L1 cache	32-KB instruction and 32-KB write-back data cache
L2 cache	2 MB
External bus frequency	533 MHz

System Information	
System chipset	Intel 915GM (integrated video), ICH60M, or Intel 915PM (discrete video), ICH60M
Processor Side Data bus width	64 bits
DRAM bus width	DDR2 dual channel 400 MHz/533 MHz (independent 64-bit memory data channels)
Processor address bus width	32 bits
Flash EPROM	1 MB
Graphics bus	integrated
PCI bus	32 bits

PC Card	
CardBus controller	Texas Instruments PCI 6515 CardBus controller (support for USB express cards through adapter in CardBus slot)
PC Card connector	one (supports one Type I or Type II card)
Cards supported	3.3 V and 5 V
PC Card connector size	68 pins
Data width (maximum)	PCMCIA 16 bits CardBus 32 bits

Memory	
Memory module connector	two user-accessible SODIMM sockets
Memory module capacities	256 MB, 512 MB, and 1 GB
Memory type	400 MHz or 533 MHz 1.8-V DDR2 SDRAM SODIMM
Minimum memory	256 MB
Maximum memory	2 GB

Ports and Connectors	
Audio	microphone connector, stereo headphone/speakers connector
Infrared	sensor compatible with IrDA Standard 1.1 (Fast IR) and IrDA Standard 1.0 (Slow IR)
Mini PCI	Type IIIA Mini PCI card slot
Modem	RJ-11 port
Network adapter	RJ-45 port
Parallel	25-hole connector; unidirectional, bidirectional, or ECP
Serial	9-pin connector; 16550C-compatible, 16-byte buffer connector
S-video TV-out	7-pin mini-DIN connector (optional S-video to composite video adapter cable)
USB	4-pin USB 2.0-compliant connector
Video	15-hole connector

--

<b>Communications</b>	
Modem:	
Type	v.92 56K MDC (optional)
Controller	softmodem
Interface	internal AC'97 bus
Network adapter	10/100/1000 Ethernet LAN on system board
Wireless	internal Mini PCI Wi-Fi (802.11b, 802.11b/g, or 802.11a/b/g) and Bluetooth® wireless technology (optional)

<b>Video</b>	
<b>NOTE:</b> Your Dell™ Latitude™ D610 computer has both integrated and discrete video options.	
Video type:	integrated on system board, 128-bit hardware accelerated
Data bus	integrated video
Video controller	Intel Extreme Graphics
Video memory	Integrated video up to 128 MB of shared system memory.  <b>NOTE:</b> Up to 128 MB shared if total computer memory is 512 MB or greater; up to 64 MB shared if total computer memory is less than 512 MB.
LCD interface	LVDS
TV support	NTSC or PAL in S-video and composite modes
Color output	16.7 million
Video type:	discrete video adapter, 128-bit hardware accelerated
Data bus	PCI-E x16
Video controller	ATI Mobility Radeon X300
Video memory	64 MB
LCD interface	LVDS
TV support	NTSC or PAL in S-video and composite modes
Color output	16.7 million

<b>Audio</b>	
Audio type	AC'97 (Soft Audio)
Audio controller	Sigmatel 9751
Stereo conversion	18-bit (analog-to-digital) 20-bit (digital-to-analog)
Interfaces:	
Internal	AC'97
External	microphone-in connector, stereo headphones/speakers connector
Speaker	two 4-ohm speakers
Internal speaker amplifier	2-W channel into 4 ohms
Volume controls	keyboard shortcuts, program menus, mute and volume-up/down buttons

<b>Display</b>	
Type (active-matrix TFT)	XGA; SXGA+
Dimensions:	
Height	214.3 mm (8.4 inches)
Width	285.7 mm (11.3 inches)
Diagonal	357.1 mm (14.1 inches)
Maximum resolutions:	
XGA	1024 x 768 at 262,000 colors

SXGA+	1400 x 1050 at 262,000 colors
Operating angle	0° (closed) to 180°
Viewing angles:	
Horizontal	±40°
Vertical	+10°/-30°
Pixel pitch:	
XGA	0.28 mm (12.1 inch); 0.297 mm (14.1 inch)
SXGA+	0.204 mm (14.1 inch)
Power consumption (panel with backlight) (maximum):	
XGA	6.0 W
SXGA+	6.5 W
Controls	brightness can be controlled through keyboard shortcuts

<b>Keyboard</b>	
Number of keys	87 (U.S. and Canada); 88 (Europe); 91 (Japan)
Layout	QWERTY/AZERTY/Kanji

<b>Touch Pad</b>	
X/Y position resolution (graphics table mode)	240 cpi
Size:	
Width	64.88 mm (2.55-inch) sensor-active area
Height	48.88-mm (1.92-inch) rectangle

<b>Track Stick</b>	
X/Y position resolution (graphics table mode)	250 count/sec @ 100 gf
Size	protrudes 0.5 mm higher than surrounding keycaps

<b>Battery</b>	
Type	6-cell "smart" lithium ion (53 WHr) (standard) 4-cell "smart" lithium ion (32 WHr) (optional)
Dimensions:	
Depth	88.5 mm (3.48 inches)
Height	21.5 mm (0.83 inch)
Width	139.0 mm (5.47 inches)
Weight	0.32 kg (0.70 lb) (6 cell) 0.25 kg (0.56 lb) (4 cell)
Voltage	14.8 VDC
Charge time (approximate):	
Computer on	2.5 hours
Computer off	1 hour
Operating time	varies depending on operating conditions and can be significantly reduced under certain power-intensive conditions  See <a href="#">Using a Battery</a> for more information on battery life and operating time.
Life span (approximate)	300 discharge/charge cycles
Temperature range:	
Operating	0° to 35°C (32° to 95°F)
Storage	-20° to 65°C (-4° to 149°F)

<b>AC Adapter</b>	



**NOTE:** The 90-W AC adapter is optional and may not ship with your computer.

Types	90 W and 65 W
Input voltage	90–264 VAC (both)
Input current (maximum)	1.7 A (both)
Input frequency	47–63 Hz (both)
Output current:	
90 W	5.62 A (maximum at 4-second pulse); 4.62 A (continuous)
65 W	4.34 A (maximum at 4-second pulse); 3.34 A (continuous)
Output power	90 W or 65 W
Rated output voltage	19.5 VDC (both)
Dimensions:	
Height	33.8–34.6 mm (1.34–1.36 inches) (90 W) 27.8–28.6 mm (1.10–1.12 inches) (65 W)
Width	60.9 mm (2.39 inches) (90 W) 57.9 mm (2.28 inches) (65 W)
Length	153.42 mm (6.04 inches) (90 W) 137.2 mm (5.40 inches) (65 W)
Weight (without cables)	0.46 kg (1.01 lb) (90 W) 0.36 kg (0.79 lb) (65 W)
Temperature range:	
Operating	0° to 35°C (32° to 95°F) (both)
Storage	–40° to 65°C (–40° to 149°F) (both)

<b>Physical</b>	
Height	34.3 mm (1.4 inches)
Width	312.0 mm (12.5 inches)
Depth	262.2 mm (10.5 inches)
Weight:	
With travel module	2.2 kg (4.85 lb) (6 cell) 2.1 kg (4.68 lb) (4 cell)
With CD drive	2.4 kg (5.29 lb) (6 cell)

<b>Environmental</b>	
Temperature range:	
Operating	0° to 35°C (32° to 95°F)
Storage	–40° to 65°C (–40° to 149°F)
Relative humidity (maximum):	
Operating	10% to 90% (noncondensing)
Storage	5% to 95% (noncondensing)
Maximum vibration (using a random-vibration spectrum that simulates user environment):	
Operating	0.66 GRMS
Storage	1.30 GRMS
Maximum shock (measured with hard drive in head-parked position and a 2-ms half-sine pulse):	
Operating	142 G, 70 in/s
Storage	163 G
Altitude (maximum):	
Operating	–15.2 to 3048 m (–50 to 10,000 ft)
Storage	–15.2 to 10,668 m (–50 to 35,000 ft)

[Back to Contents Page](#)

## Dell™ Latitude™ D610 User's Guide

Click the links to the left for information on the features and operation of your computer. For information on other documentation included with your computer, see "[Finding Information](#)."



**NOTE:** A NOTE indicates important information that helps you make better use of your computer.



**NOTICE:** A NOTICE indicates either potential damage to hardware or loss of data and tells you how to avoid the problem.



**CAUTION:** A CAUTION indicates a potential for property damage, personal injury, or death.

For a complete list of abbreviations and acronyms, see the [Glossary](#).

If you purchased a Dell™ n Series computer, any references in this document to Microsoft® Windows® operating systems are not applicable.



**NOTE:** Some features may not be available for your computer or in certain countries.

Information in this document is subject to change without notice.

© 2004–2005 Dell Inc. All rights reserved.

Reproduction in any manner whatsoever without the written permission of Dell Inc. is strictly forbidden.

Trademarks used in this text: *Dell*, the *DELL* logo, *Inspiron*, *Dell Precision*, *Dimension*, *OptiPlex*, *Latitude*, *Dell TravelLite*, *PowerEdge*, *PowerVault*, *PowerApp*, *ExpressCharge*, *Strike Zone*, and *Dell OpenManage* are trademarks of Dell Inc.; *Intel*, *Intel SpeedStep*, and *Pentium* are registered trademarks of Intel Corporation; *Microsoft*, *MS-DOS*, *Outlook*, and *Windows* are registered trademarks of Microsoft Corporation; *Bluetooth* is a registered trademark owned by Bluetooth SIG, Inc. and is used by Dell Inc. under license; *EMC* is a registered trademark of EMC Corporation; *ENERGY STAR* is a registered trademark of the U.S. Environmental Protection Agency. As an ENERGY STAR partner, Dell Inc. has determined that this product meets the ENERGY STAR guidelines for energy efficiency.

Other trademarks and trade names may be used in this document to refer to either the entities claiming the marks and names or their products. Dell Inc. disclaims any proprietary interest in trademarks and trade names other than its own.

Model PP11L

December 2005 P/N P4946 Rev. A03

---

[Back to Contents Page](#)

## Travelling With Your Computer

### Dell™ Latitude™ D610 User's Guide

- [Identifying Your Computer](#)
  - [Packing the Computer](#)
  - [Travel Tips](#)
- 

### Identifying Your Computer

- 1 Attach a name tag or business card to the computer.
  - 1 Write down your Service Tag and store it in a safe place away from the computer or carrying case. Use the Service Tag if you need to report a loss or theft to law enforcement officials and to Dell.
  - 1 Create a file on the Microsoft® Windows® desktop called **if\_found**. Place information such as your name, address, and telephone number in this file.
  - 1 Contact your credit card company and ask if it offers coded identification tags.
- 

### Packing the Computer

- 1 Remove any external devices attached to the computer and store them in a safe place. Remove any cables attached to installed PC Cards, and [remove any extended PC Cards](#).
- 1 To make the computer as light as possible, replace any devices installed in the module bay with the Dell TravelLite™ module.
- 1 Fully charge the main battery and any spare batteries you plan to carry with you.
- 1 Shut down the computer.
- 1 Disconnect the AC adapter.

➡ **NOTICE:** When the display is closed, extraneous items on the keyboard or palm rest could damage the display.

- 1 Remove any extraneous items, such as paper clips, pens, and paper, from the keyboard and palm rest and close the display.
- 1 Use the optional Dell™ carrying case to pack the computer and its accessories together safely.
- 1 Avoid packing the computer with items such as shaving cream, colognes, perfumes, or food.
- 1 Protect the computer, the batteries, and the hard drive from hazards such as extreme temperatures and overexposure to sunlight, dirt, dust, or liquids.

➡ **NOTICE:** If the computer has been exposed to extreme temperatures, allow it to acclimate to room temperature for 1 hour before turning it on.

- 1 Pack the computer so that it does not slide around in the trunk of your car or in an overhead storage compartment.

➡ **NOTICE:** Do not check the computer as baggage.

---

### Travel Tips

➡ **NOTICE:** Do not move the computer while using the optical drive. Doing so can result in loss of data.

- 1 Consider disabling wireless activity on your computer to maximize battery operating time. To disable wireless activity, press <Fn><F2>.
- 1 Consider changing your power management options to maximize battery operating time.
- 1 If you are travelling internationally, carry proof of ownership—or of your right to use the computer if it is company-owned—to speed your passage through customs. Investigate the customs regulations of the countries you plan to visit, and consider acquiring an international carnet (also known as a *merchandise passport*) from your government.
- 1 Ensure that you know which electrical outlets are used in the countries you will visit, and have appropriate power adapters.
- 1 Check with your credit card company for information about the kinds of emergency travel assistance it offers to users of portable computers.

### Travelling by Air

- 1 Ensure that you have a charged battery available in case you are asked to turn on the computer.

➡ **NOTICE:** Do not walk the computer through a metal detector. Send the computer through an X-ray machine or have it hand inspected.

- 1 Before you use the computer on an airplane, verify that such usage is permitted. Some airlines forbid the use of electronic devices during the flight. All airlines forbid the use of electronic devices during takeoff and landing.

## If Your Computer Is Lost or Stolen

- 1 Call a law enforcement agency to report the lost or stolen computer. Include the Service Tag in your description of the computer. Ask that a case number be assigned and write down the number, along with the name, address, and telephone number of the law enforcement agency. If possible, obtain the name of the investigating officer.

 **NOTE:** If you know where the computer was lost or stolen, call a law enforcement agency in that area. If you do not know, call a law enforcement agency where you live.

- 1 If the computer belongs to a company, notify the security office of the company.
- 1 Contact Dell customer service to report the missing computer. Provide the computer Service Tag, the case number, and the name, address, and telephone number of the law enforcement agency to which you reported the missing computer. If possible, give the name of the investigating officer.

The Dell customer service representative will log your report under the computer Service Tag and flag the computer as missing or stolen. If someone calls Dell for technical assistance and gives your Service Tag, the computer is identified automatically as missing or stolen. The representative will attempt to get the phone number and address of the caller. Dell will then contact the law enforcement agency to which you made the report of the missing computer.

---

[Back to Contents Page](#)

[Back to Contents Page](#)

# Wireless Local Area Network

Dell™ Latitude™ D610 User's Guide

- [Overview](#)
  - [Connecting to a Wireless Local Area Network](#)
- 

## Overview

A WLAN is a series of interconnected computers that communicate with each other over the air waves rather than through a network cable connected to each computer. In a WLAN, a radio communications device called an access point or wireless router connects network computers and provides Internet, or network, access. The access point or wireless router and the wireless network card in the computer communicate by broadcasting data from their antennas over the air waves.

## What You Need to Establish a WLAN Connection

Before you can set up a WLAN, you need:

- 1 High-speed (broadband) Internet access (such as cable or DSL)
- 1 A broadband modem that is connected and working
- 1 A wireless router or access point
- 1 A wireless network card for each computer that you want to connect to your WLAN
- 1 A network cable with the network (RJ-45) connector

## Checking Your Wireless Network Card

Depending on what you selected when you purchased your computer, the computer has a variety of configurations. To confirm that your computer has a wireless network card and to determine the type of card, use one of the following:

- 1 The **Start** button and the **Connect To** option
- 1 The order confirmation for your computer

## Start Button and Connect To Option

1. Click the **Start** button.
2. Point to **Connect To**, and then click **Show all connections**.

If **Wireless Network Connection** does not appear under **LAN or High-Speed Internet**, you may not have a wireless network card.

If **Wireless Network Connection** appears, you have a wireless network card. To view detailed information about the wireless network card:

1. Right-click **Wireless Network Connection**.
2. Click **Properties**. The **Wireless Network Connection Properties** window appears. The wireless network card's name and model number are listed on the **General** tab.

 **NOTE:** If your computer is set to the **Classic Start** menu option, you can view network connections by clicking the **Start** button, pointing to **Settings**, and then pointing to **Network Connections**. If **Wireless Network Connection** does not appear, you may not have a wireless network card.

## The Order Confirmation for Your Computer

The order confirmation that you received when you ordered your computer lists the hardware and software that shipped with your computer.

## Setting Up a New WLAN

### Connecting a Wireless Router and a Broadband Modem

1. Contact your Internet service provider (ISP) to obtain specific information about the connection requirements for your broadband modem.
2. Ensure that you have wired Internet access through your broadband modem before you attempt to set up a wireless Internet connection.
3. Install any software required for your wireless router. Your wireless router may have been shipped with an installation CD. Installation CDs usually contain installation and troubleshooting information. Install the required software according to the instructions provided by the router manufacturer.
4. Shut down your computer and any other wireless-enabled computers in the vicinity through the **Start** menu.
5. Disconnect your broadband modem power cable from the electrical outlet.
6. Disconnect the network cable from the computer and the modem.

 **NOTE:** Wait for a minimum of 5 minutes after disconnecting your broadband modem before you continue with the network setup.

7. Disconnect the AC adapter cable from your wireless router to ensure that there is no power connected to the router.
8. Insert a network cable into the network (RJ-45) connector on the unpowered broadband modem.
9. Connect the other end of the network cable into the Internet network (RJ-45) connector on the unpowered wireless router.
10. Ensure that no network or USB cables, other than the network cable connecting the modem and the wireless router, are connected to the broadband modem.

 **NOTE:** Restart your wireless equipment in the order described below to prevent a potential connection failure.

11. Turn on *only* your broadband modem and wait for at least 2 minutes for the broadband modem to stabilize. After 2 minutes, proceed to [step 12](#).
12. Turn on your wireless router and wait for at least 2 minutes for the wireless router to stabilize. After 2 minutes, proceed to the [step 13](#).
13. Start your computer and wait until the boot process completes.
14. See the documentation that came with your wireless router to do the following in order to set up the wireless router:
  1. Establish communication between your computer and your wireless router.
  1. Configure your wireless router to communicate with your broadband router.
  1. Find out your wireless router's broadcast name. The technical term for the name of your router's broadcast name is Service Set Identifier (SSID) or network name.
15. If necessary, configure your wireless network card to connect to the wireless network. See [Connecting to a Wireless Local Area Network](#).

---

## Connecting to a Wireless Local Area Network

 **NOTE:** Before you connect to a WLAN, ensure that you have followed the instructions in [Setting Up a New WLAN](#).

 **NOTE:** The following networking instructions do not apply to internal cards with Bluetooth<sup>®</sup> wireless technology or cellular products.

This section provides general procedures for connecting to a network via wireless technology. Specific network names and configuration details vary. See [Setting Up a New WLAN](#) for more information about how to prepare for connecting your computer to a WLAN.

Your wireless network card requires specific software and drivers for connecting to a network. The software is already installed.

 **NOTE:** If the software is removed or corrupted, follow the instructions in the user documentation for your wireless network card. Verify the type of wireless network card installed in your computer and then search for that name on the Dell Support website at [support.dell.com](http://support.dell.com). For information on the type of wireless network card that is installed in your computer, see [Checking Your Wireless Network Card](#).

## Determining the Wireless Network Device Manager

Depending on the software installed on your computer, different wireless configuration utilities may manage your network devices:

1. Your wireless network card's client utility
1. The Windows XP operating system

To determine which wireless configuration utility is managing your wireless network card:

1. Click the **Start** button, point to **Settings**, and then click **Control Panel**.

2. Double-click **Network Connections**.
3. Right-click the **Wireless Network Connection** icon, and then click **View Available Wireless Networks**.

If the **Choose a wireless network** window states **Windows cannot configure this connection**, the wireless network card's client utility is managing the wireless network card.

If the **Choose a wireless network** window states **Click an item in the list below to connect to a wireless network in range or to get more information**, the Windows XP operating system is managing the wireless network card.

For specific information about the wireless configuration utility installed on your computer, see your wireless network documentation in the Windows Help and Support Center.

To access the Help and Support Center:

1. Click the **Start** button and click **Help and Support**.
2. Under **Pick a Help topic**, click **Dell User and System Guides**.
3. Under **Device Guides**, select the documentation for your wireless network card.

## Completing the Connection to the WLAN

When you turn on your computer and a network (for which your computer is not configured) is detected in the area, a pop-up appears near the network icon in the notification area (in the lower-right corner of the Windows desktop).

Follow the instructions provided in any utility prompts that appear on your screen.

Once you have configured your computer for the wireless network that you selected, another pop-up notifies you that your computer is connected to that network.

Thereafter, whenever you log on to your computer within the range of the wireless network that you selected, the same pop-up notifies you of the wireless network connection.

 **NOTE:** If you select a secure network, you must enter a WEP or WPA key when prompted. Network security settings are unique to your network. Dell cannot provide this information.

 **NOTE:** Your computer can take up to 1 minute to connect to the network.

## Enabling/Disabling the Wireless Network Card

 **NOTE:** If you are unable to connect to a wireless network, ensure that you have all the components for establishing a WLAN (see [What You Need to Establish a WLAN Connection](#)), and then verify that your wireless network card is enabled by pressing <Fn><F2>.

You can turn your computer's wireless networking function on and off by pressing the <Fn><F2> key combination.

---

[Back to Contents Page](#)

[Back to Contents Page](#)

## Using Microsoft® Windows® XP

### Dell™ Latitude™ D610 User's Guide

- [Help and Support Center](#)
  - [User Accounts and Fast User Switching](#)
  - [Microsoft® Windows® Classic View](#)
  - [Setting Up a Home and Office Network](#)
  - [Desktop Cleanup Wizard](#)
  - [Network Setup Wizard](#)
  - [Transferring Information to a New Computer](#)
  - [Internet Connection Firewall](#)
- 

## Help and Support Center

 **NOTE:** The Microsoft® Windows® XP Home Edition and Windows XP Professional operating systems have different features and appearances. Also, options available in Windows XP Professional vary depending on whether your computer is connected to a domain.

The Help and Support Center provides help with Windows XP and offers other support and educational tools. With the Help and Support Center, you can:

1. Access user's guides for your computer hardware and software.
1. Find detailed information about your computer, including configuration and error logs.
1. Access support and educational tools installed on your computer.
1. Search for topics based on words you provide.

To access the Help and Support Center, click the **Start** button and click **Help and Support**.

---

## Microsoft® Windows® Classic View

You can change the appearance of the Windows desktop, **Start** menu, and Control Panel so that they look more like previous versions of the Windows operating system.

 **NOTE:** The procedures in this document were written for the Windows default view, so they may not work if you set your Dell™ computer to the Windows classic view.

## Desktop

1. Click the **Start** button and click **Control Panel**.
2. Under **Pick a category**, click **Appearance and Themes**.
3. Under **Pick a task...**, click **Change the computer's theme**.
4. In the **Theme** drop-down menu, click **Windows Classic**.
5. Click **OK**.

## Start Menu

1. Right-click the **Start** button and click **Properties**.
2. Click the **Start Menu** tab.
3. Click **Classic Start menu** and click **OK**.

## Control Panel

1. Click the **Start** button and click **Control Panel**.
  2. In the left panel, click **Switch to Classic View**.
-



## Desktop Cleanup Wizard

Your computer is set up to use the Desktop Cleanup Wizard to move programs that are not frequently used to a designated folder 7 days after you first start your computer and every 60 days after that. The appearance of the **Start** menu changes as programs are moved.

To turn off the Desktop Cleanup Wizard, perform the following steps.

 **NOTE:** You can run the Desktop Cleanup Wizard any time by clicking **Clean Desktop Now** under **Run Desktop Cleanup Wizard every 60 days**.

1. Right-click an empty spot on the desktop and click **Properties**.
2. Click the **Desktop** tab and click **Customize Desktop**.
3. Click **Run Desktop Cleanup Wizard every 60 days** to remove the check mark.
4. Click **OK**.

To run the Desktop Cleanup Wizard at any time:

1. Right-click an empty spot on the desktop and click **Properties**.
  2. Click the **Desktop** tab and click **Customize Desktop**.
  3. Click **Clean Desktop Now**.
  4. When the Desktop Cleanup Wizard appears, click **Next**.
  5. In the list of shortcuts, deselect any shortcuts you want to leave on the desktop and click **Next**.
  6. Click **Finish** to remove the shortcuts and close the wizard.
- 

## Transferring Information to a New Computer

The Microsoft® Windows® XP operating system provides a Files and Settings Transfer wizard to move data from the source computer to the new computer. You can move data such as:

1. E-mails
1. Toolbar settings
1. Window sizes
1. Internet bookmarks

You can transfer the data to the new computer over a network or serial connection, or you can store it on a removable medium, such as a writable CD or floppy.

To prepare the new computer for the file transfer:

1. Click the **Start** button, point to **All Programs**→ **Accessories**→ **System Tools**, and then click **Files and Settings Transfer Wizard**.
2. When the **Files and Settings Transfer Wizard** welcome screen appears, click **Next**.
3. On the **Which computer is this?** screen, click **New Computer** and click **Next**.
4. On the **Do you have a Windows XP CD?** screen, click **I will use the wizard from the Windows XP CD** and click **Next**.
5. When the **Now go to your old computer** screen appears, go to your old or source computer. *Do not* click **Next** at this time.

To copy data from the old computer:

1. On the old computer, insert the Windows XP *Operating System* CD.
2. On the **Welcome to Microsoft Windows XP** screen, click **Perform additional tasks**.
3. Under **What do you want to do?**, click **Transfer files and settings**.
4. On the **Files and Settings Transfer Wizard** welcome screen, click **Next**.

5. On the **Which computer is this?** screen, click **Old Computer** and click **Next**.
6. On the **Select a transfer method** screen, click the transfer method you prefer.
7. On the **What do you want to transfer?** screen, select the items you want to transfer and click **Next**.

After the information has been copied, the **Completing the Collection Phase** screen appears.

8. Click **Finish**.

To transfer data to the new computer:

1. On the **Now go to your old computer** screen on the new computer, click **Next**.
2. On the **Where are the files and settings?** screen, select the method you chose for transferring your settings and files and click **Next**.

The wizard reads the collected files and settings and applies them to your new computer.

When all of the settings and files have been applied, the **Finished** screen appears.

3. Click **Finished** and restart the new computer.

---

## User Accounts and Fast User Switching

### Adding User Accounts

After the Microsoft® Windows® XP operating system is installed, the administrator or a user with administrator rights can create additional user accounts.

1. Click the **Start** button and click **Control Panel**.
2. In the **Control Panel** window, click **User Accounts**.
3. Under **Pick a task**, click **Create a new account**.
4. Under **Name the new account**, type the name of the new user and click **Next**.
5. Under **Pick an account type**, click one of the following options:
  1. **Computer administrator** — You can change all computer settings.
  1. **Limited** — You can change only your own personal settings, such as your password. You cannot install programs or use the Internet.

 **NOTE:** Additional options may be available, depending on whether you are using Windows XP Home Edition or Windows XP Professional. Also, options available in Windows XP Professional vary depending on whether your computer is connected to a domain.

6. Click **Create Account**.

### Fast User Switching

 **NOTE:** Fast User Switching is unavailable if your computer is running Windows XP Professional and is a member of a computer domain, or if your computer has less than 128 MB of memory.

Fast User Switching allows multiple users to access one computer without requiring the previous user to log off.

1. Click the **Start** button and click **Log Off**.
2. In the **Log Off Windows** window, click **Switch User**.

When you use Fast User Switching, programs that previous users were using remain running in the background, which might slow your computer's response time. Also, multimedia programs, such as games and DVD software, might not work with Fast User Switching. For more information, see the [Help and Support Center](#).

---

## Setting Up a Home and Office Network

1. Connect the network cable to the network adapter connector on the back of your computer.

 **NOTE:** Insert the cable until it clicks into place, and then gently pull it to ensure that it is secure.

2. Connect the other end of the network cable to a network connection device, such as a network wall connector.

 **NOTE:** Do not use a network cable with a telephone wall connector.



---

## Network Setup Wizard

The Microsoft® Windows® XP operating system provides a Network Setup Wizard to guide you through the process of sharing files, printers, or an Internet connection between computers in a home or small office.

1. Click the **Start** button, point to **All Programs**→ **Accessories**→ **Communications**, and then click **Network Setup Wizard**.
2. On the welcome screen, click **Next**.
3. Click **Checklist for creating a network**.

 **NOTE:** Selecting the connection method labeled "**This computer connects directly to the Internet**" enables the integrated firewall provided with Windows XP Service Pack 1 (SP1).

4. Complete the checklist and required preparations.
5. Return to the Network Setup Wizard and follow the instructions on the screen.

---

## Internet Connection Firewall

The Internet Connection Firewall provides basic protection from unauthorized access to the computer while the computer is connected to the Internet. The firewall is automatically enabled when you run the Network Setup Wizard. When the firewall is enabled for a network connection, the firewall icon appears with a red background in the **Network Connections** section of the Control Panel.

Note that enabling the Internet Connection Firewall does not reduce the need for virus-checking software.

For more information, see the [Help and Support Center](#).

---

[Back to Contents Page](#)